



Project _____

Item 522ETSG30602 Quantity _____

Approval _____ Date _____

Steelton 30" x 60" 18 Gauge 430 Stainless Steel Work Table with Undershef and 2" Rear Uprturn

Item #522ETSG30602

Special Features

- Made of 18 gauge, type 430 stainless steel
- Galvanized steel legs and undershef
- Ideal for lower volume kitchens and startups
- Undershef is adjustable
- Rolled front edge with 2" rear upturn

Technical Data

Length	60 Inches
Width	30 Inches
Height	36 Inches
Backsplash Height	2 Inches
Work Surface Height	34 Inches
Backsplash	With Backsplash
Features	Customizable Height NSF Certified With Undershef
Gauge	18 Gauge



Certifications



NSF Certified

Technical Data

Leg Construction	Galvanized Steel
Number of Legs	4 Legs
Size	30" x 60"
Stainless Steel Type	Type 430
Tabletop Material	Stainless Steel
Top Capacity	679 lb.
Type	Work Tables
Undershelf Capacity	396 lb.
Undershelf Construction	Galvanized Steel
Usage	Light Duty

Technical Drawing

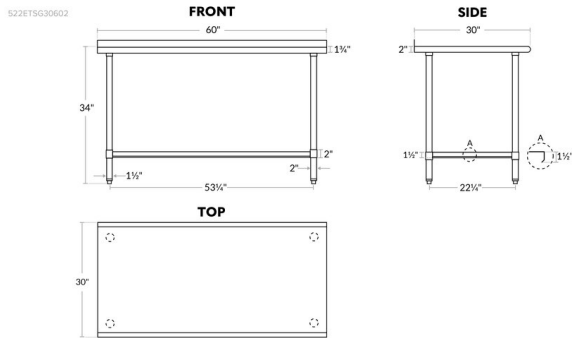

⚠ WARNING: This product can expose you to chemicals including lead, which are known to the State of California to cause cancer and birth defects or other reproductive harm. For more information, go to www.p65warnings.ca.gov.