



Project \_\_\_\_\_

Item 522EBTKD3048D Quantity \_\_\_\_\_

Approval \_\_\_\_\_ Date \_\_\_\_\_

# Steelton 30" x 48" 16 Gauge Type 430 Stainless Steel Enclosed Base Sliding Door Table

Item #522EBTKD3048D

## Special Features

- Durable 16 gauge type 430 stainless top with an 18 gauge type 430 stainless steel cabinet body
- Ships knocked down, saving on shipping costs
- 2 sliding doors with recessed handles fully conceal the cabinet base's contents
- Stainless steel legs, sockets, and bullet feet
- Large 30" x 48" worktop

## Technical Data

<b>Length</b>	48 Inches
<b>Width</b>	30 Inches
<b>Height</b>	34 Inches
<b>Backsplash Height</b>	Without Backsplash
<b>Work Surface Height</b>	34 Inches
<b>Backsplash</b>	Without Backsplash
<b>Color</b>	Silver
<b>Door Style</b>	Sliding
<b>Features</b>	NSF Certified With Undershelf



## Certifications



NSF Certified

## Technical Data

<b>Gauge</b>	16 Gauge
<b>Leg Construction</b>	Stainless Steel
<b>Material</b>	Stainless Steel
<b>Number of Doors</b>	2 Doors
<b>Number of Legs</b>	4 Legs
<b>Stainless Steel Type</b>	Type 430
<b>Table Style</b>	Enclosed Base
<b>Tabletop Material</b>	Stainless Steel
<b>Top Capacity</b>	730 lb.
<b>Type</b>	Work Tables

## Technical Drawing

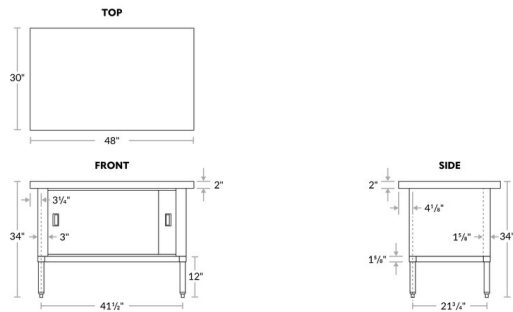

**⚠ WARNING:** This product can expose you to chemicals including lead, which are known to the State of California to cause cancer and birth defects or other reproductive harm. For more information, go to [www.p65warnings.ca.gov](http://www.p65warnings.ca.gov).