



BEVERAGE-AIR®

PROJECT: _____
 ITEM # _____ QTY: _____
 MODEL # _____
 AIA # _____ SIS # _____
 APPROVED: _____

SANDWICH PREP TABLES

Model: SPE60HC-16

TWO DOOR STANDARD TOP



7 YEAR WARRANTY Parts, Labor, and Compressor

CABINET CONSTRUCTION

- Stainless steel front, sides, top, door and grille (galvanized back & bottom)
- Interior liner is made of corrosion resistant aluminum
- Full electronic control
- Removable hoods made of matching stainless steel
- Airflow assures that product in open containers is kept below 41°F and above freezing
- Self-closing door with 120° stay-open feature on cartridge style hinges
- Easy door removal for service and cleaning
- Snap-in magnetic gaskets for positive door seal
- Painted aluminum door handle
- 10" Wide cutting board constructed of white polyethylene plastic
- Cutting board removable for cleaning
- Four (4) epoxy coated wire shelves
- (16) 1/6 size polycarbonate pans are included
- 6" Casters, with (2) brakes standard



OPTIONS & ACCESSORIES

- Stainless steel back
- Stainless steel interior
- Clear lid
- Left hinged door (at time of order)
- Door lock
- Overshelves (single or double)
- Crumb catcher kit
- Richlite cutting board
- Night cover
- Epoxy coated shelves
- Shelf clips
- Shelf dividers
- Bottle organizer
- Bun rack
- Pan supports
- Pan support crossbar
- 6" Legs or 3" casters
- Low profile casters
- Remote option* (see note on back page)

REFRIGERATION SYSTEM

- Uses environmentally friendly, energy efficient R290 refrigerant, and meets all regulatory requirements for CARB, SNAP, DOE & more
- Adaptive defrost
- Epoxy coated evaporator coil
- Enhanced airflow maintains temperature between 36° to 38°F



BEVERAGE-AIR®

Sandwich Prep Tables Model: SPE60HC-16

PLAN VIEW

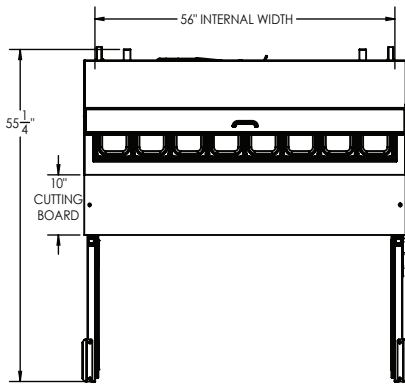

ELEVATION VIEW

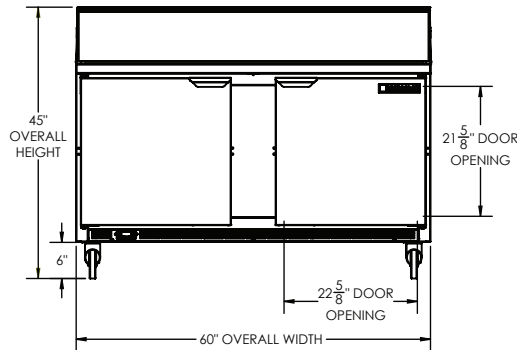

SIDE VIEW

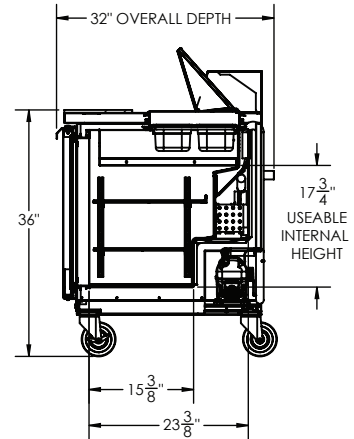

EXTERNAL DIMENSIONAL DATA

Width Overall (in)	60"
Depth Overall (in)	32"
Height Overall (in)	45"
Number of Doors	2
Depth with Door Open 90°	55 1/4"
Door opening (in.)	22 5/8" x 21 5/8"
Depth, Cutting Board	10"

INTERNAL DIMENSIONAL DATA

NET Capacity (cubic ft.)	16.02
Internal Width Overall (in)	56"
Internal Depth Overall (in)	15 3/8"
Internal Height Overall (in)	17 3/4"
Number of Shelves	4

*NOTE: Remote units are field wired and come with 6" legs.
Refrigerant must be specified at time of order.

We reserve the right to change specifications and product design without notice. Such revisions do not entitle the buyer to corresponding changes, improvements, additions or replacements for previously purchased equipment. Dimensional tolerances +/- 1/4". Metric dimensions (MM).

ELECTRICAL DATA

Full Load Amps	5.4
Voltage	115/60/1
Nema Plug (8' cord)	5-15P

REFRIGERATION DATA

Horsepower	1/3
Capacity (BTU/Hr)	1549
Heat Rejection (BTU/Hr)	2323.5
Charge (lbs/grams/ounces)	0.2095 / 95 / 3.35

SHIPPING DATA

Gross Weight - Crated	346 lbs.
Height - Crated (in)	44"
Width - Crated (in)	63"
Depth - Crated (in)	35"

ELECTRICAL CONNECTION



115/60/1
NEMA 5-15P

Unit pre-wired at factory and include 8' long cord and plug set.

Required Clearance: 3" Bottom & 2" Rear

3779 Champion Blvd., Winston-Salem, NC 27105 | 888-845-9800 | Fax: 336-245-6453 | Beverage-Air.com | Sales@bevair.com

Date Issued 2/26 | Printed in U.S.A.