

REGENCY
Tables and Sinks

Regency 30" x 60" 16-Gauge 304 Stainless Steel Wall Mounted Table with 4 1/2" Backsplash

#600WMTB3060



Technical Data

Length	60 Inches
Width	30 Inches
Backsplash Height	4 1/2 Inches
Backsplash	With Backsplash
Features	NSF Certified
Gauge	16 Gauge
Size	30" x 60"
Stainless Steel Type	Type 304
Table Style	Wall Mounted
Tabletop Material	Stainless Steel

Features

- Spacious 30" x 60" tabletop
- 16-gauge type 304 stainless steel top
- Wall-mounted design saves precious floor space
- 4 1/2" backsplash

Certifications



Plan View

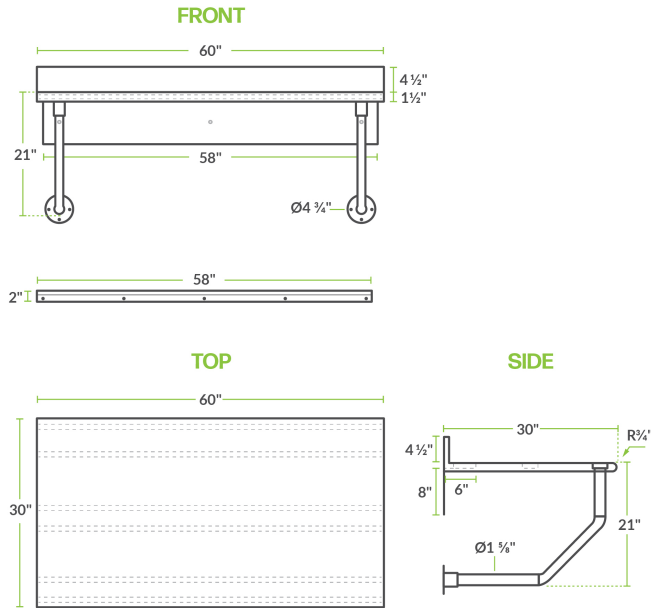

Notes & Details

This Regency 30" x 60" 16-gauge 304 stainless steel wall mounted table is a perfect way to increase your usable workspace, while providing more stability and taking up less room than a conventional worktable! Built to withstand heavy use, this unit features a 16-gauge stainless steel top, while a 4" backsplash helps protect your walls from dirt and debris.

It installs by mounting the top to a right angle bracket (secured to the wall), and mounting the 4 3/4" tubular wall brackets into a steel, wall mounted embossed flange to provide additional support. Due to the wall-mounted design, users are given flexibility to place the table at any height, ensuring it will fit in any environment. This wall mounted table is ideal for environments with frequent wash downs, and is quick and convenient to set up. Mounting hardware is sold separately.

⚠ WARNING: This product can expose you to chemicals including lead, which are known to the State of California to cause cancer and birth defects or other reproductive harm. For more information, go to www.p65warnings.ca.gov.