



Regency 54" Three Compartment Commercial Utility Sink with 18" x 18" x 14" Sink Bowls

#600S31818SB



Technical Data

Length	54 Inches
Width	21 1/2 Inches
Height	41 Inches
Bowl Depth	14 Inches
Backsplash Height	8 3/4 Inches
Work Surface Height	33 Inches
Backsplash	With Backsplash
Bowl Front to Back	18 Inches
Bowl Left to Right	18 Inches
Faucet Centers	8 Inches

Features

- Constructed of corrosion-resistant, 16 gauge, type 304 stainless steel
- Galvanized steel legs and adjustable bullet feet provide stability
- Deep 18" x 18" x 14" sink bowls accommodate large items
- Accepts wall-mounted faucets on 8" centers (faucet sold separately)
- Ideal for a variety of janitorial or commercial kitchen applications

Technical Data

Features	Massachusetts Accepted Plumbing Product
Gauge	16 Gauge
Installation Type	Freestanding
Leg Construction	Galvanized Steel
Material	Stainless Steel
Number of Compartments	3 Compartments
Number of Drainboards	None
Stainless Steel Type	Type 304
Style	0 Drainboards
Type	Commercial Sinks

Plan View

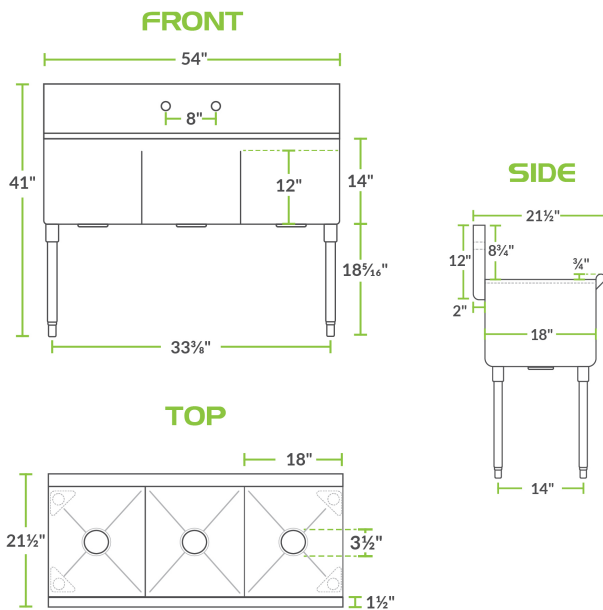

Notes & Details

This Regency three compartment commercial utility sink is a great economical choice for an array of establishments. It's constructed from sturdy, 16 gauge, type 304 stainless steel, making it more corrosion-resistant and durable than other sinks made from thinner, 18 gauge material. It also boasts three 18" x 18" x 14" sink bowls, perfect for accommodating larger items such as mop buckets. A 1 1/2" IPS drain and a convenient strainer basket come standard with this unit.

With three compartments, you can utilize the space in your kitchen to create an efficient workflow. An 8 3/4" tall backsplash is included to protect your walls, and it comes complete with two holes punched on 8" centers for a wall-mounted faucet (sold separately). The legs are constructed of galvanized steel with bullet feet with 1" of adjustability, so you can install this sink to best fit your needs. Designed for medium-duty use, this Regency sink is ideal for various janitorial and commercial kitchen applications.

WARNING: This product can expose you to chemicals including lead, which are known to the State of California to cause cancer and birth defects or other reproductive harm. For more information, go to www.p65warnings.ca.gov