



Regency Spec Line 30" x 48" 14-Gauge 304 Stainless Steel Commercial Open Base Work Table with 4" Backsplash

#600WTS30X48B



Technical Data

Length	48 Inches
Width	30 Inches
Height	38 Inches
Backsplash Height	4 Inches
Work Surface Height	34 Inches
Backsplash	With Backsplash
Base Style	Open
Configuration	Straight
Features	ADA Compliant NSF Certified

Features

- Type 304 stainless steel top offers excellent durability and corrosion-resistance
- 4" backsplash contains spills and keeps items from falling off the back
- 1 5/8" stainless steel legs with adjustable metal bullet feet
- Perfect for a variety of prep tasks
- Open base allows for additional storage space and adjustable feet provide stability

Certifications



ADA Compliant



NSF Certified

Technical Data

Gauge	14 Gauge
Leg Construction	Stainless Steel
Number of Legs	4 Legs
Stainless Steel Type	Type 304
Table Style	Open Base
Tabletop Material	Stainless Steel
Top Capacity	720 lb.
Usage	Heavy Duty

Plan View

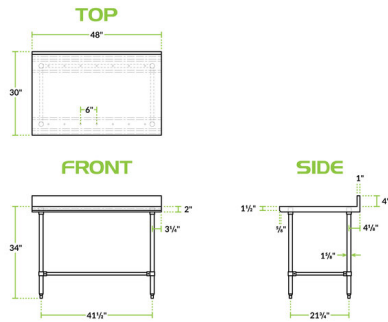

Notes & Details

This Regency Spec Line 30" x 48" stainless steel commercial open base work table is a versatile addition to your kitchen. Constructed from durable, easy-to-clean 14-gauge, 304-series stainless steel, this work table offers superior corrosion resistance and durability compared to other work tables made of 430-series stainless steel. Due to its stainless steel construction, it's built to withstand the daily tasks in your restaurant, cafe, or bakery. Great for rolling out dough or chopping fruits and vegetables, you can provide your staff with additional work space to complete tasks efficiently. To protect your walls during food prep, this work table features a 4" backsplash with a 1" return.

With a working height of 34", you can create a comfortable work station for your employees. For increased stability, this work table includes 1 1/4" diameter stainless steel cross bracing and (4) 1 5/8" diameter 18 gauge stainless steel legs. Adjustable, stainless steel bullet feet allow you set up your table to best fit your needs, while its open base makes it easy to store large ingredient bins or add custom shelving underneath.

WARNING: This product can expose you to chemicals including lead, which are known to the State of California to cause cancer and birth defects or other reproductive harm. For more information, go to www.p65warnings.ca.gov.