



Regency Spec Line 18" Five-Tiered Stainless Steel Liquor Display Rack - 29" Deep

#600LDR1829S



Technical Data

Length	18 Inches
Width	29 Inches
Height	37 Inches
Backsplash Height	7 Inches
Work Surface Height	30 Inches
Maximum Bottle Diameter	3 5/16 Inches
Backsplash	With Backsplash
Capacity	20 Bottles
Features	Spec Line
Gauge	14 - 18 Gauge

Features

- Five-tiered design holds approximately 20 liquor bottles
- 18 gauge stainless steel body with 14 gauge sides
- Superior sound-deadened construction
- Stainless steel legs with U-shaped cross bracing and bullet feet
- 16 gauge steel bars hold bottles in place

Technical Data

Leg Construction	Stainless Steel
Material	Stainless Steel
Number of Tiers	5 Tiers
Product Line	Regency Spec Line
Stainless Steel Type	Type 304
Type	Liquor Displays

Plan View

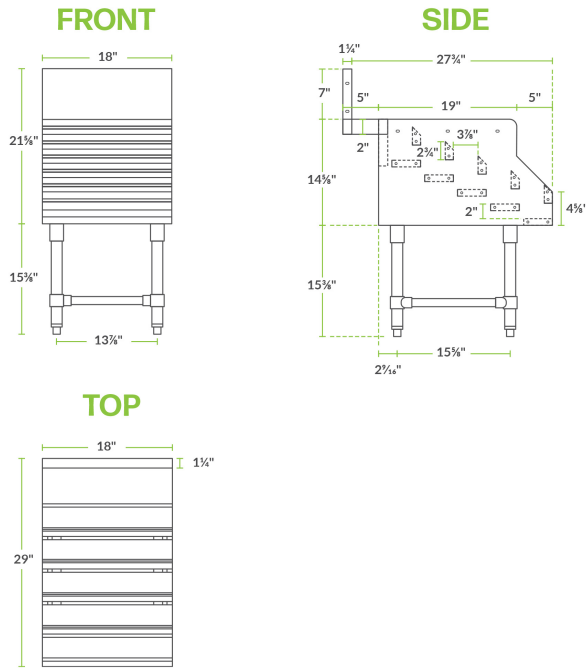

Notes & Details

Effectively store liquor bottles within convenient reach of the bartender while creating a unique display for customers with this Regency Spec Line liquor display rack! At 29" deep, this rack accommodates approximately 20 liquor bottles and, thanks to the stepped five-tiered design, all bottles are clearly on display at all times. Plus, with superior sound-deadened construction, removing and adding bottles is quieter than ever!

Built for reliable, long-lasting performance, this Regency liquor display rack features an 18 gauge type 304 stainless steel body with 14 gauge stainless steel sides. That not only makes for a durable addition to your bar setup, but also one that is extremely simple to clean! 16 gauge steel bars hold bottles in place for added assurance. The stainless steel legs with U-shaped cross bracing provide added stability and rest upon plastic bullet feet.