



## Regency Spec Line 24" x 24" Underbar Ice Bin with 10 Circuit Post-Mix Cold Plate and Bottle Holders - 77 lb.

#600IB2424CPS



### Technical Data

Length	24 Inches
Width	24 Inches
Height	30 Inches
Ice Bin Length	22 Inches
Ice Bin Width	15 3/16 Inches
Backsplash Height	7 Inches
Post Diameter	1 Inch
Capacity	77 lb.
Drain Outlet Size	1 Inch
Gauge	20 Gauge

### Features

- 20 gauge, corrosion-resistant type 304 stainless steel bin; 77 lb. capacity
- 2 plastic bottle holders and a 7" backsplash limits messes
- Stainless steel legs with U-shaped cross bracing and bullet feet
- 10 circuit post-mix cold plate chills up to 10 different beverage lines
- 1" IPS drain

### Certifications



## Technical Data

Features	Bottle Storage NSF Certified Spec Line With Backsplash
Installation Type	Freestanding
Insulation Material	Foam
Leg Construction	Stainless Steel
Material	Stainless Steel
Number of Cold Plate Circuits	10 Circuits
Stainless Steel Type	Type 304
Type	Ice Bins With Cold Plate

## Plan View

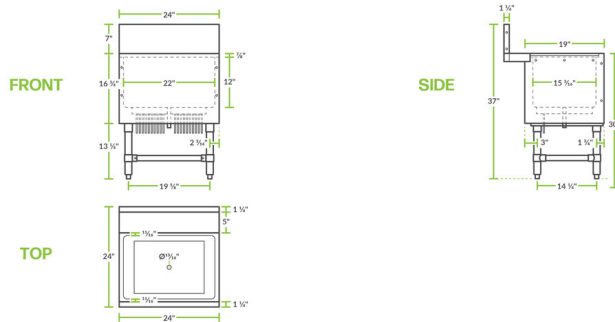

## Notes & Details

Whether you're serving up a delicious cocktail or a refreshing soda, ensure you have a steady supply of cold beverages at your bar thanks to this Regency Spec Line underbar ice bin! This convenient unit not only holds plenty of ice but also boasts a post-mix cold plate with stainless steel, beverage-grade tubing circuits that allow you to run up to 10 soda lines through the bin to chill them before serving. The interior bowl holds ice, while two plastic bottle holders with removable dividers let you simultaneously chill your most popular liquors and mixers. A 1" IPS drain pipe safely drains melted ice water from the unit, so you're only left with solid pieces.

This Regency ice bin is constructed of 20 gauge, corrosion-resistant type 304 stainless steel and features foam insulation to help keep the bin's contents cooler longer. With its 77 lb. ice capacity, this heavy-duty bin holds plenty of ice to keep your operation going, customer after customer. It rests atop stainless steel legs with U-shaped cross bracing and bullet feet for ultimate stability. It also boasts a tall 7" backsplash to help keep your walls and floors dry. Perfect for full bar line builds, this underbar ice bin features rivet holes for attaching accessories or joining equipment for a seamless behind-the-bar bar setup! Thanks to this unit's versatility, it's easy to store and chill everything you need to create the perfect gin and tonic, whiskey ginger, cranberry vodka, and other popular drinks at your busy bar, nightclub, or restaurant.