



Regency 18" x 42" 14-Gauge Stainless Steel Floor Trough with Grate

#600FT1842SS



Technical Data

Length	42 Inches
Width	18 Inches
Depth	4 Inches
Features	NSF Certified
Gauge	14 Gauge
Material	Stainless Steel
Stainless Steel Type	Type 304
Style	Stainless Steel Grate
Type	Floor Troughs

Features

- Features a sturdy 14-gauge, type 304 stainless steel construction
- Comes with a 3" long, 4" diameter plumbing sleeve
- Includes a removable strainer basket for optimal convenience
- Designed with a removable 3/16" x 1" subway-style grating
- Flanges mount directly to the subfloor for added stability

Certifications



Plan View

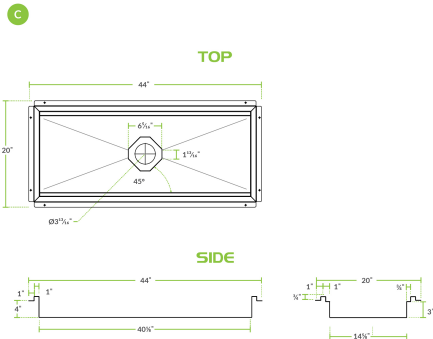
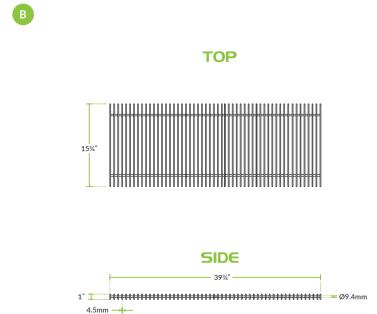
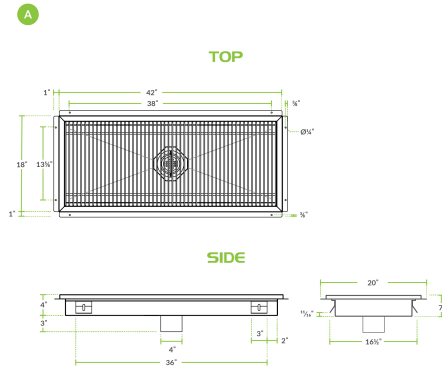
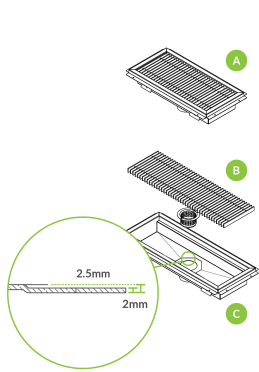

Notes & Details

Maintain safe and sanitary floor conditions in your busy back-of-house area with this Regency 18" x 42" 14-gauge stainless steel floor trough with grate. Featuring a durable 14-gauge, type 304 stainless steel construction, this item was built for increased longevity and everyday use. Not only is it great for installation beneath steam equipment in your restaurant's kitchen, allowing for efficient end-of-day draining, but also it can be utilized within any establishment that requires draining of excessive amounts of water. Not to mention, the flanges around the perimeter mount directly to the subfloor to provide added stability.

This Regency floor trough comes with a removable 3/16" x 1" subway-style grating that boasts an even 9/16" spacing between each bar. This spacing permits fluids to easily flow through, and it blocks potential clogs while enabling equipment and casters to roll over the trough without getting stuck. Plus, this item was constructed with a convenient creased design to ensure proper draining into its 3" long plumbing sleeve, which accommodates waste pipes up to 4" in diameter. It even includes a removable strainer basket for effortless cleaning!

WARNING: This product can expose you to chemicals including lead, which are known to the State of California to cause cancer and birth defects or other reproductive harm. For more information, go to www.p65warnings.ca.gov