



BEVERAGE-AIR®

PROJECT: _____
 ITEM # _____ QTY: _____
 MODEL # _____
 AIA # _____ SIS # _____
 APPROVED: _____

DELI/PIZZA PREP TABLES

Model: DPD72HC-3

THREE DRAWER ONE DOOR

7 YEAR WARRANTY

Parts, Labor, and Compressor



CABINET CONSTRUCTION

- Stainless steel front, sides, top, doors, drawers and grille (galvanized back & bottom)
- Interior liner is made of corrosion resistant aluminum
- Aluminum top interior liner prevents spill from falling into cabinet
- Stainless steel top
- Removable hoods and insulated lid assemblies are made of matching stainless steel
- Self-closing doors with 120° stay-open feature on cam-lift hinges
- Magnetic gaskets provide positive seal on both door and drawers
- Field reversible doors
- 3" Casters, 2 with brakes standard
- 19" Wide reversible cutting board is removable for easy cleaning
- Two (2) epoxy-coated steel wire shelves
- Units will accept pans up to 6" deep (pans are not included)
- Drawer frames are heavy-duty stainless steel
- 12-Gauge stainless steel drawer slides with Delrin® rollers rated at 275 lbs
- Telescoping slides, with locking mechanism to prevent drawers from being pulled off of cabinet
- Heavy-duty pan locking divider supports are standard in drawers
- Compressor available on left or right, specify at time of unit order



OPTIONS & ACCESSORIES

- Stainless steel back
- Stainless steel interior
- Clear lid
- Overshelf kits
- Additional shelves
- Shelf clips
- Pan support
- Door lock
- Composite cutting board
- Thermometer
- Night cover
- Bun tray rack
- 6" Casters
- 6" Legs black or seismic/flanged
- Remote option* (see note on back page)

REFRIGERATION SYSTEM

- Uses environmentally friendly, energy efficient R290 refrigerant, and meets all regulatory requirements for CARB, SNAP, DOE & more
- Adaptive defrost
- Epoxy coated evaporator coil
- Enhanced airflow maintains temperature between 36° to 38°F



BEVERAGE-AIR®

Deli/Pizza Prep Tables Model: DPD72HC-3

PLAN VIEW

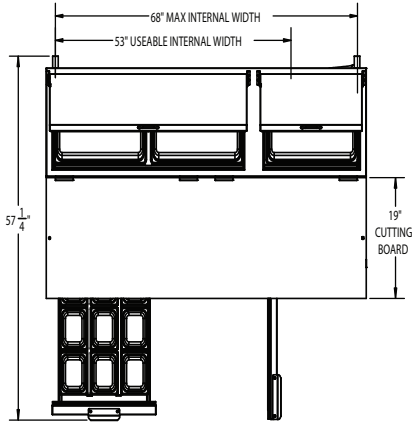

ELEVATION VIEW

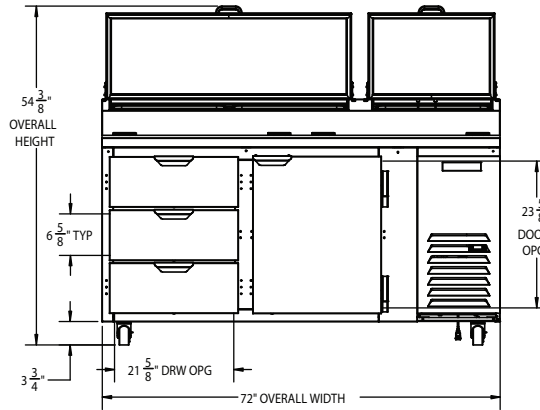

SIDE VIEW

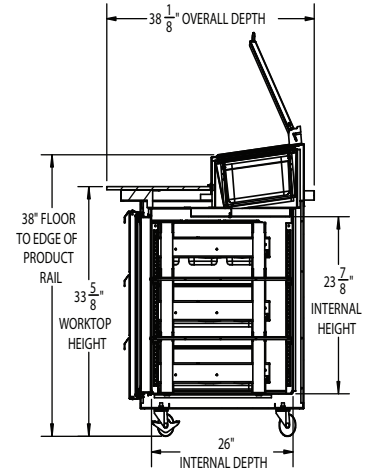

Required Clearance: 3" Bottom & 2" Rear

EXTERNAL DIMENSIONAL DATA

Width Overall (in)	72"
Depth Overall (in)	38 1/8"
Height Overall (in)	54 3/8"
Number of Doors	1
Number of Drawers	3
Door opening (in.)	21 5/8" x 23 5/8"
Depth, Cutting Board	19"

INTERNAL DIMENSIONAL DATA

NET Capacity (cubic ft.)	22.8
Internal Width Overall (in)	68"
Internal Width Usable (in)	53"
Internal Depth Overall (in)	26"
Internal Height Overall (in)	23 7/8"
Number of Shelves	2
Depth with Drawers Extended	57 1/4"
Drawers Openings	21 5/8" x 6 5/8"

ELECTRICAL DATA

Full Load Amps	4.5
Voltage	115/60/1
Nema Plug (8' cord)	5-15P

REFRIGERATION DATA

Horsepower	1/2
Capacity (BTU/Hr)	2940
Heat Rejection (BTU/Hr)	4410
Charge (lbs/grams/ounces)	0.2315 / 105 / 3.7

SHIPPING DATA

Gross Weight - Crated	554 lbs.
Height - Crated (in)	49"
Width - Crated (in)	78"
Depth - Crated (in)	40"

ELECTRICAL CONNECTION



115/60/1
NEMA 5-15P

Unit pre-wired at factory and include 8' long cord and plug set.

*NOTE: Remote units are field wired and come with 6" legs.
Refrigerant must be specified at time of order.

We reserve the right to change specifications and product design without notice. Such revisions do not entitle the buyer to corresponding changes, improvements, additions or replacements for previously purchased equipment. Dimensional tolerances +/- 1/4". Metric dimensions (MM).

3779 Champion Blvd., Winston-Salem, NC 27105 | 888-845-9800 | Fax: 336-245-6453 | Beverage-Air.com | Sales@bevair.com

Date Issued 4/26 | Printed in U.S.A.