

FS-OB MERCHANDISER with R-290 Refrigerant

WARNINGS:

If the information in these instructions are not followed exactly, a fire or explosion may result, causing property damage or personal injury.

Installation and service must be performed by a qualified installer or service agency.

**READ THE ENTIRE MANUAL BEFORE
INSTALLING OR USING THIS EQUIPMENT.**

The unit uses R-290 gas as the refrigerant. R-290 is flammable and heavier than air. It collects first in low areas but can be circulated by the fans. If propane gas is present or even suspected, do not allow untrained personnel to attempt to find the cause. The propane gas used in the unit has no odor. The lack of smell does not indicate a lack of escaped gas. If a leak is detected, immediately evacuate all persons from the store, and contact the local fire department to advise them that a propane leak has occurred. Do not let any persons back into the store until the qualified service technician has arrived and that technician advises that it is safe to return to the store. No open flames, cigarettes or other possible sources of ignition should be used inside or in the vicinity of the units.

**FAILURE TO ABIDE BY THIS WARNING COULD
RESULT IN AN EXPLOSION, INJURY AND
PROPERTY DAMAGE.**

IMPORTANT
Keep in store for future reference!



Installation, Operation and Service Manual

P/N 3214313

November 2025

Rev. C



BEFORE YOU BEGIN
Read these instructions completely and carefully.



PERSONAL PROTECTION EQUIPMENT (PPE)

Personal Protection Equipment (PPE) is required whenever installing or servicing this equipment. Always wear safety glasses, gloves, protective boots or shoes, long pants, and a long-sleeve shirt as required when installing or servicing this equipment.

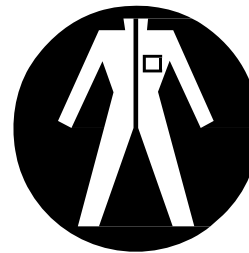

1. If the information in these instructions are not followed exactly, a fire or explosion may result, causing property damage or personal injury.
2. Installation and service must be performed by a qualified installer or service agency.
3. This unit is designed only for use with R-290 (Propane) gas as the designated refrigerant.

THE REFRIGERANT LOOP IS SEALED. ONLY A QUALIFIED TECHNICIAN SHOULD ATTEMPT TO SERVICE!

- Propane is flammable and heavier than air.
- It collects first in the low areas but can be circulated by the fans.
- If R-290 (Propane) is present or even suspected, do not allow untrained personnel to attempt to find the cause.
- The propane gas used in the unit has no odor.
- The lack of smell does not indicate a lack of escaped gas.
- If a leak is detected, immediately evacuate all persons from the store, and contact the local fire department to advise them that a propane leak has occurred.
- Do not let any persons back into the store until the qualified service technician has arrived and that technician advises that it is safe to return to the store.
- A hand-held propane leak detector ("sniffer") shall be used before any repair and/or maintenance.
- No open flames, cigarettes or other possible sources of ignition should be used inside the building where the units are located until the qualified service technician and/or local fire department determines that all propane has been cleared from the area and from the refrigeration systems.
- Component parts are designed for propane and non-incendive and non-sparking. Component parts shall only be replaced with identical repair parts.

FAILURE TO ABIDE BY THIS WARNING COULD RESULT IN INJURY AND PROPERTY DAMAGE.





This warning does not mean that Hussmann products will cause cancer or reproductive harm, or is in violation of any product-safety standards or requirements. As clarified by the California State government, Proposition 65 can be considered more of a 'right to know' law than a pure product safety law. When used as designed, Hussmann believes that our products are not harmful. We provide the Proposition 65 warning to stay in compliance with California State law. It is your responsibility to provide accurate Proposition 65 warning labels to your customers when necessary. For more information on Proposition 65, please visit the California State government website.



ANSI Z535.5 DEFINITIONS

 • **DANGER** – Indicate[s] a hazardous situation which, if not avoided, will result in serious injury.

 • **WARNING** – Indicate[s] a hazardous situation which, if not avoided, could result in serious injury.

 • **CAUTION** – Indicate[s] a hazardous situation which, if not avoided, could result in minor or moderate injury.

 • **GROUNDING CONNECTION** – Indicate[s] a grounding connection on the appliance.

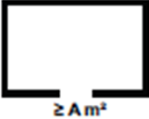
 • **MINIMUM ROOM FLOOR AREA** – Indicate[s] the minimum floor area required for installation of the appliance.

 • **DANGER** – Indicate[s] a risk of fire or explosion. Flammable refrigerant used. To be repaired only by trained service personnel. Do not puncture refrigerant tubing.

• **NOTICE** – *Not related to personal injury* – Indicates[s] situations, which if not avoided, could result in damage to equipment.

⚠ WARNING

Keep all ventilation openings clear of obstruction.

All installation and operating instructions concerning the handling, moving, and use of these merchandisers must be carefully followed to avoid either damaging the refrigerant tubing, or increasing the risk of a leak.

Do not damage the refrigerant circuit.

Do not use means to accelerate the defrosting process or to clean, other than those recommended by the manufacturer.

The appliance shall be stored in a room without continuously operating ignition sources (for example: open flames, an operating gas appliance or an operating electric heater).

Do not pierce or burn.

Be aware that refrigerants may not contain an odour.

⚠ WARNING

Do not use electrical appliances inside the food/storage compartments unless they are of the type recommended by the manufacturer.

In order to reduce flammability hazards, the installation of this appliance must only be carried out by a suitably qualified person.

Component parts shall be replaced with like components, and servicing shall be done by factory authorized service personnel only, so as to minimize the risk of possible ignition due to incorrect parts or improper service.

Product will degrade and may spoil if allowed to sit in non-refrigerated area.

Table of Contents

CONTENT	SUB CONTENT	PAGE
Notice on Loading and Handling		6
General Information		7-8
Section and Plan Views		9
Installation	Preparation	10-11
	Method for Leveling	12
User Information	Startup and Setup	13
	Clearances	14-15
	Checklist	16
Maintenance	Cleaning Exterior and Interior	18-19
	Maintenance Tips	20
Electrical	General Information	21-22
	Component Locations	23
	Self-Contained Component Locations	24
	Controller Information	25-27
Refrigeration	Leak Detection	28
	Serial Plate Location /Piping	29
	Service and/or Repair	30-32
	Water Outlet	33
Trouble Shooting		34-35
Service	Evaporator Fan Replacement	36
	LED Driver Replacement	37

IMPORTANT
KEEP IN STORE FOR FUTURE REFERENCE
Quality that sets industry standards!

1299 St. Charles Rock Road Bridgeton, MO 63044-2483
U.S. & Canada 1-800-922-1949 Mexico 800-890-2900
www.hussmann.com

© 2024 Hussman Coporation

Notice



-DO NOT Load or stand over the top of the case.
Glass breakage may occur if precautions are disregarded.

-Broken glass can cause lacerations, cuts, and puncture wounds which may result in severed arteries or tendons, amputations, eye injuries, or exposure to disease.

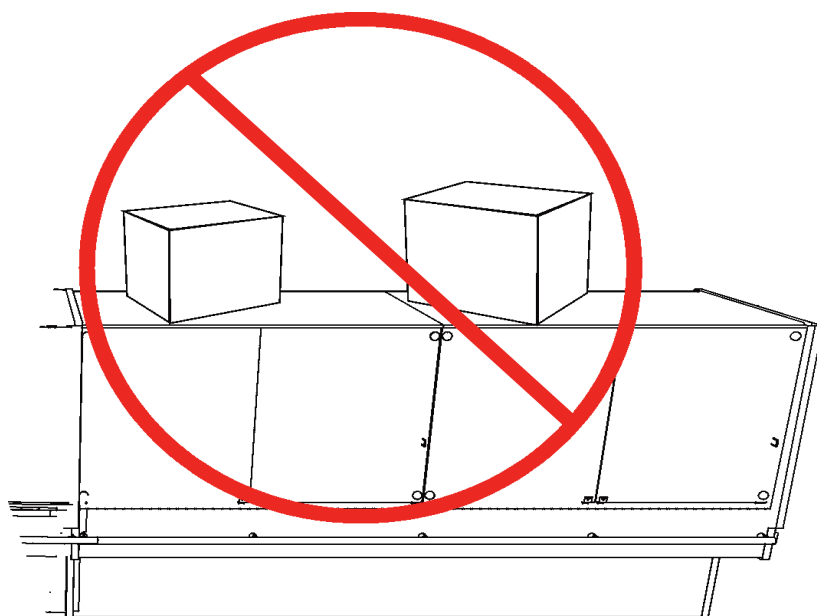

IMPORTANT

-DO NOT ATTEMPT TO MOVE THE MERCHANDISER BY APPLYING FORCE TO THE GLASS/PLEX AREA (EVEN IF WOODEN BRACES ARE PRESENT)

-APPLY PUSHING FORCES IN AREAS SHOWN AND DO NOT APPLY FORCES TO AREAS HIGHLIGHTED IN ORDER TO BRING MERCHANDISER TO THE FINAL POSITION

General Information

Case Description:

Description: Open Self-Service Merchandiser

Shipping Damage: All equipment should be thoroughly examined for shipping damage before and during unloading. This equipment has been carefully inspected at our factory and the carrier has assumed responsibility for safe arrival. If damaged, either apparent or concealed, claim must be made to the carrier Immediately.

Apparent Loss or Damage: If there is an obvious loss or damage, it must be noted on the freight bill or express receipt and signed by the carrier's agent; otherwise, carrier may refuse claim. The carrier will supply necessary claim forms.

Concealed Loss or Damage: When loss or damage is not apparent until after all equipment is uncrated, a claim for concealed damage is made. Make request in writing to carrier for inspection within 15 days and retain all packaging. The carrier will supply inspection report and required claim forms.

Shortages: Check your shipment for any possible shortages of material. If a shortage should exist and is found to be the responsibility of Hussmann, notify Hussmann. If such a shortage involves the carrier, notify the carrier immediately, and request an inspection. Hussmann will acknowledge shortages within ten days from receipt of equipment.

Hussmann Product Control: The serial number and shipping date of all equipment have been recorded in Hussmann's files for warranty and replacement part purposes. All correspondence pertaining to warranty or parts ordering must include the serial number of each piece of equipment involved, in order to provide the customer with the correct parts.

Location/Store Conditions: The FS-OB merchandiser has been designed for use only in air-conditioned stores where temperature and humidity are maintained at or below 75°F Dry bulb and 55% relative humidity. The case is also rated to operate in Type 2 conditions (80°F / 55%RH). See specification sheets for setting changes. DO NOT allow air conditioning, electric fans, ovens, open doors or windows (etc.) to create air currents around the merchandiser, as this will impair its correct operation.

Keep this booklet with the case at all times for future reference.

HUSSMANN®



This equipment is to be installed to comply with the applicable NEC, Federal, State, and Local Plumbing and Construction Code having jurisdiction.

General Information

This appliance is accessible to the General Public.

This appliance has not been evaluated for use at elevations above 2,000 meters (6,562 Ft.).

This appliance is not intended for use by persons (including children) with reduced physical, sensory or mental capabilities, or lack of experience and knowledge, unless they have been given supervision or instruction concerning use of the appliance by a person responsible for their safety.

Children should be supervised to ensure that they do not play with the appliance.

Do not store explosive substances such as aerosol cans with a flammable propellant in this appliance.

This appliance and interconnecting refrigerant piping (if applicable) is to be installed in accordance with the Safety Standard for Refrigeration Systems, ANSI/ASHRAE 15. This appliance shall not be installed in public corridors or lobbies.

A means for disconnection must be incorporated in the fixed wiring in accordance with the wiring rules.

If the SUPPLY CORD is damaged, it must be replaced by a special cord or assembly available from the manufacturer or its service agent.

This equipment is intended for installation within a motor fuel dispensing facility. This equipment is to be installed and used in accordance with the National Electrical Code, NFPA 70, and the Code for Motor Fuel Dispensing Facilities and Repair Garages, NFPA 30. The refrigerator or freezer is to be mounted at least 450 mm (18 in) above grade level.

The test room climate class for this appliance is Climate Class 8. Climate Class 8 means the unit has been tested for maximum ambient of 75°F dry bulb and 55% relative humidity.

All piping material, pipe routing, and installation shall include protection from physical damage in operation and service and be in compliance with national and local codes and standards, such as ANSI/ASHRAE 15, IAPMO Uniform Mechanical Code, ICC International Mechanical Code, or CSA B52. All field joints shall be accessible for inspection prior to being covered or enclosed.

Precautions shall be taken to avoid excessive vibration or pulsation.

If this appliance is installed in an unventilated area, provisions must be made so that in the event of a refrigerant leak, the refrigerant will not stagnate so as to create a fire or explosion hazard. If the appliance is non-fixed, it shall be stored in an area where the room size corresponds to the room area as specified for operation and it shall be stored in a room without continuously operating open flames or other potential ignition sources.

Case Sections

FS-OB

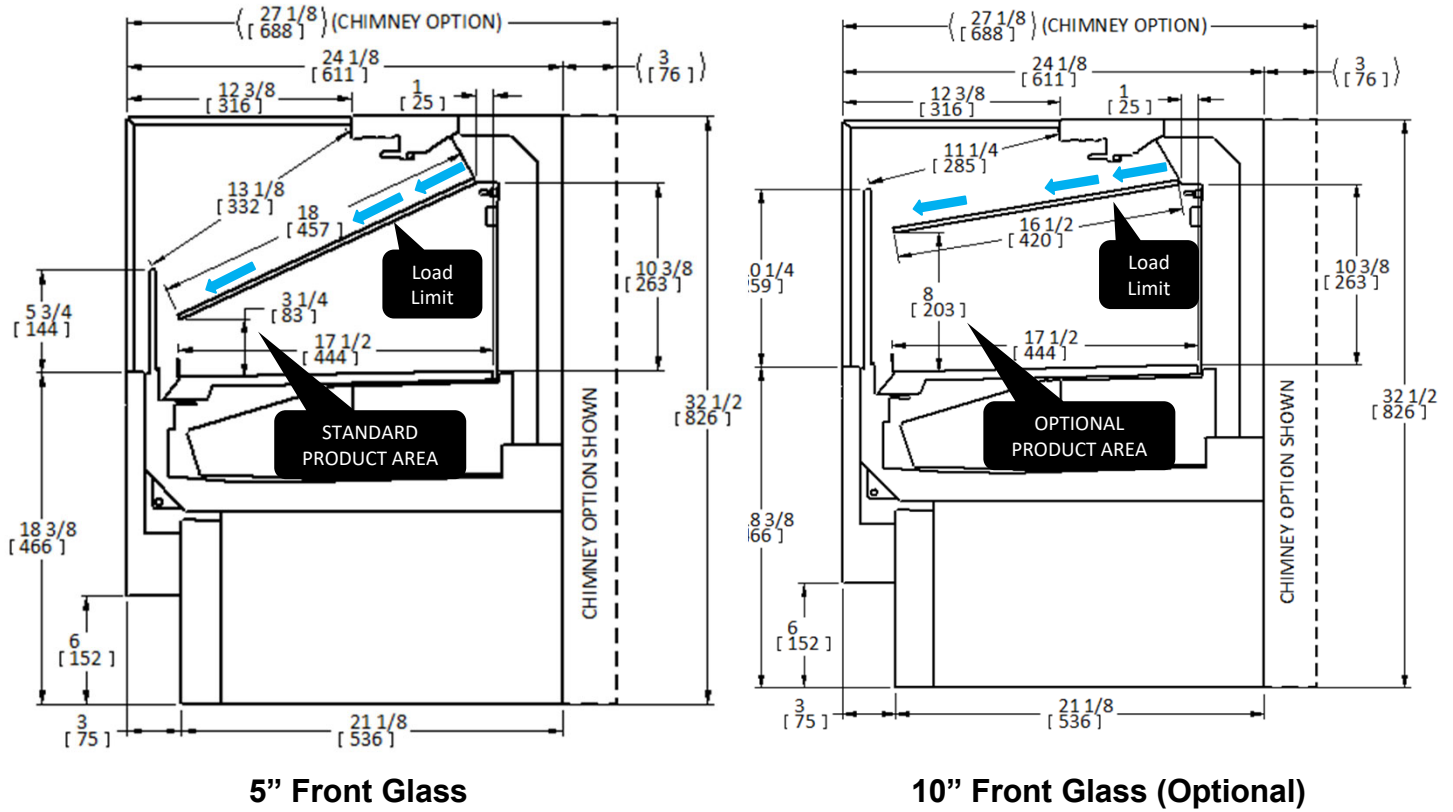

Case Plan Views

- FS-OB-35
- FS-OB-46
- FS-OB-58
- FS-OB-70

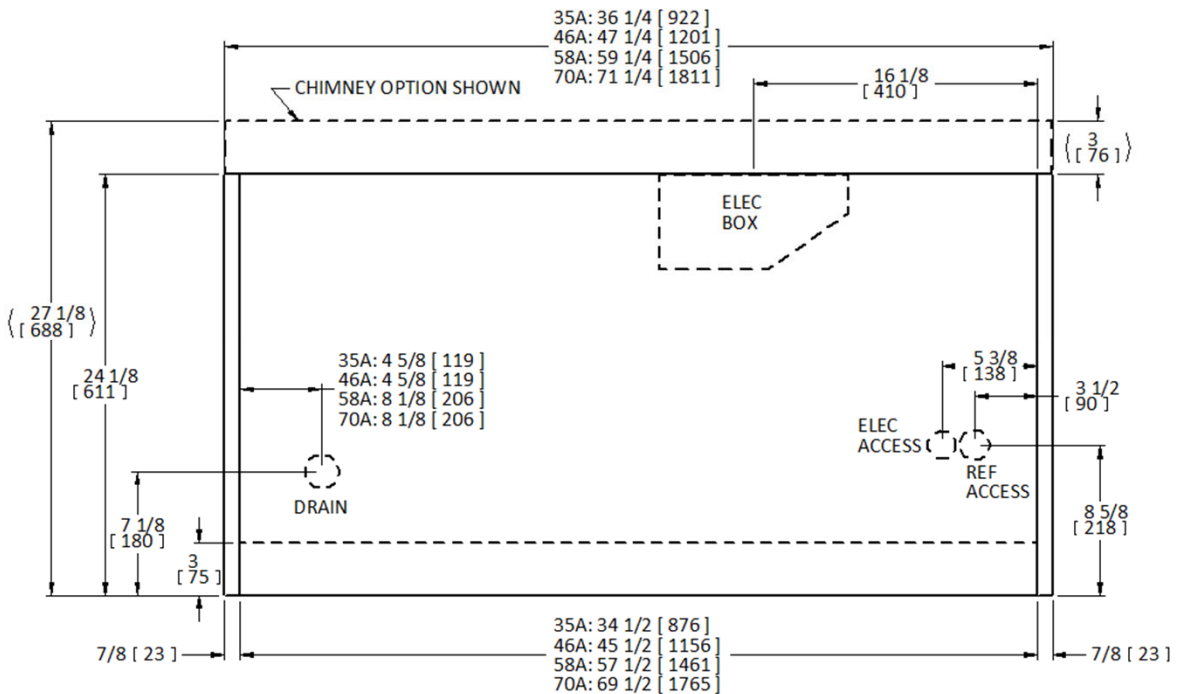

Installation – Preparation

Receiving Case and Preparing for Installation

IMPORTANT

-PLASTIC WRAP MAY BE REMOVED TO ACCESS PARTS, WARNINGS, AND INSTRUCTIONS

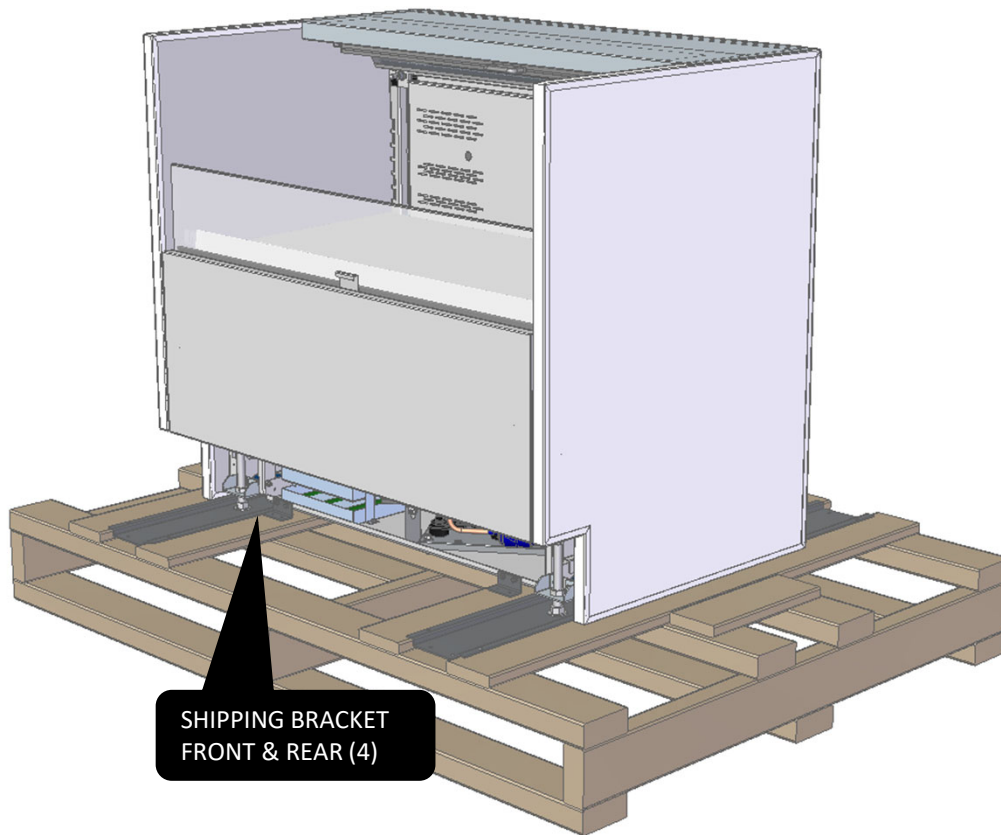

Prepare By:

1. Inspect equipment for damage. Any claim for loss or damage must be made to the carrier. The carrier will provide any necessary inspection/claim form. If there is obvious loss or damage, it must be noted on the freight bill or express receipt and signed by the carrier's agent; otherwise carrier may refuse claim.
2. Read instructions and warnings on handling and transportation. Ensure the proper transportation equipment is being used.
3. Survey and mark out the installation area and plan footprint. Snapping chalk lines is recommended.

Snapping Chalk Lines

Mark floors with Chalk snap lines where cases are to be located. Chalk lines are to run along the base or legs of cases.

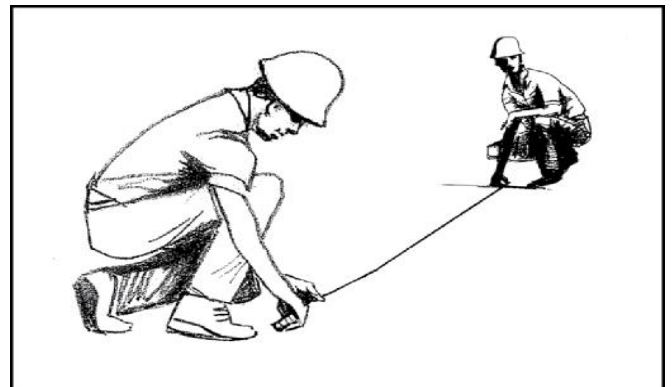

Installation – Preparation

Receiving Case and Preparing for Installation

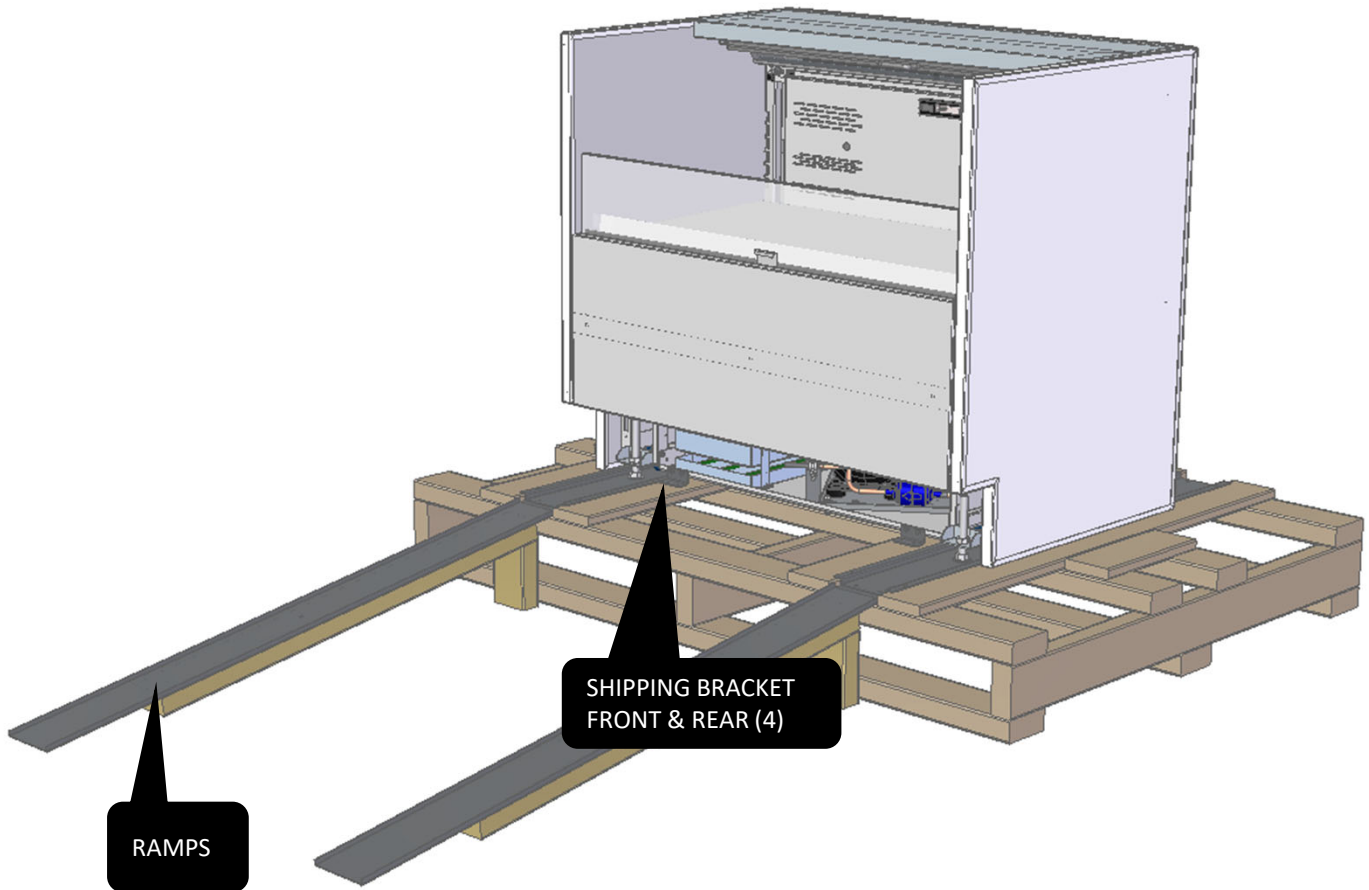

Unpacking:

(Screwdriver / Drill bit will be required to remove shipping brackets)

1. Remove any plastic, packing material & tape holding loose panels.
2. Set panels aside and install once case is in the final location.
3. Remove the rest of the plastic & packaging material.
4. Remove shipping brackets from base legs.
5. Use the ramps to unload case from skid and place in desired location.

Installation – Method for Leveling FS-OB Merchandisers

Important: See the suggestions for setting cases on uneven floors before setting lineups and leveling cases. Using this suggestion will result in the fewest required adjustments to case levels.

Place bubble level on front panel to check side-to-side levelness
IMPORTANT!
Measure levelness on both ends if level tool is not long enough to cover the entire span

Place bubble level on front panel to check front-to-back levelness
IMPORTANT!
Measure levelness on both ends if level tool is not long enough to cover the entire span

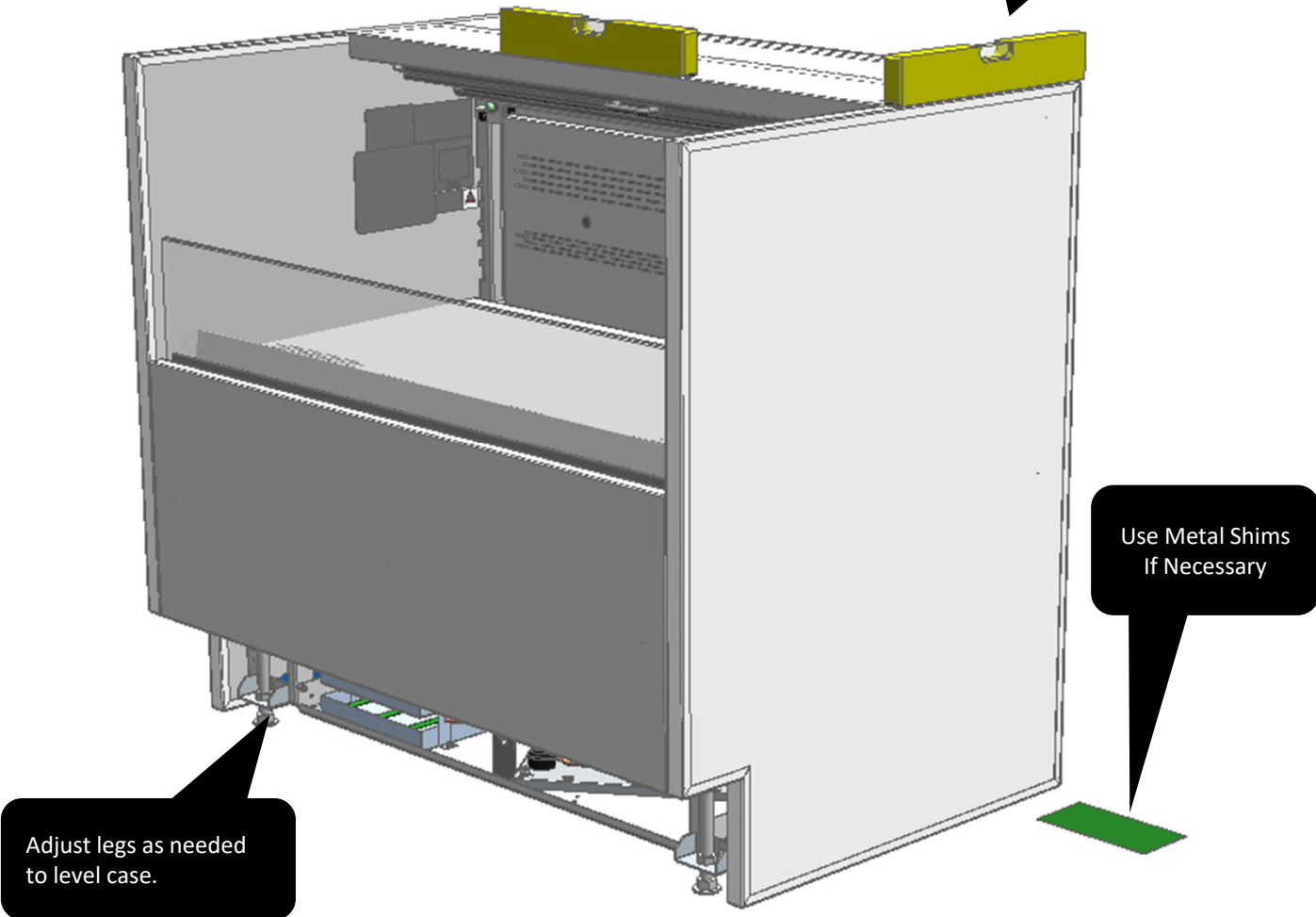

Level the Case sequentially, Using Metal Shims

- 1. Check levelness left-to-right first (This usually requires the most correction on a single side)
- 2. Adjust front-to-back levelness after ensuring left-to-right levelness (Shims normally inserted in pairs during this check).

Important: Always level the first case in the lineup. All other cases should be driven from its levels.

Note: The use of metal shims is recommended to prevent shim deterioration over time

User Information

Start Up

See the merchandisers Data Sheet Set for refrigerant settings and defrost requirements. Bring merchandisers down to the operating temperatures listed on the Data Sheet.

See page 23 for electrical component locations

Condensate Evaporator Pan Setup

Setup:

The merchandiser comes factory equipped with an Evaporator Pan, to which the drain pipes from the case feed condensate water into. There are multiple levels to collect excess water that may overflow in case of store conditions being above design specification causing more condensate water to be formed than expected.

Product Loading

Please keep product within the appropriate load limit. The load limit is indicated with a line on the case as shown on the right. It is important that the case is not overloaded with product, this would block the airflow pattern. Proper loading of product ensures the case refrigerates as specified.

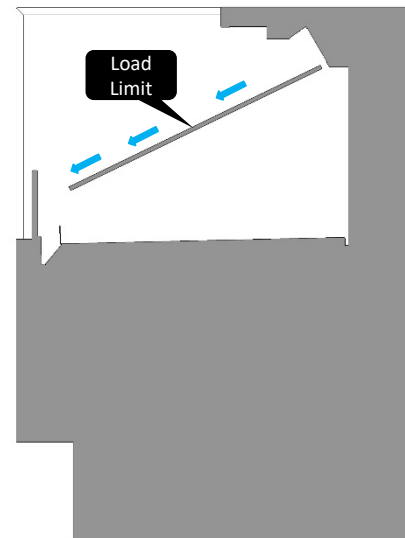

CAUTION: Obstructing air vents will affect case performance which could potentially lead to case failure.

See page 14 for air vent locations.

Clearances

-Minimum Clearances for Self-Contained case are to be followed as instructed for proper placement inside store locations.

- Intake and exhaust clearances are to be a minimum of 8 ft when placed next to a solid wall.
- Height clearance measured from floor is a minimum of 10 ft vertically.
- Minimum of 36 in. clearance if near an open aisle is required for proper cycle ventilation.
- Case set location to be at least 15 ft away from any entrance/exit door.
- Do not position the case near an HVAC vent.
- For back-to-back operation, the chimney option is required.
- The minimum floor area of the room shall be 260 Ft.² with ventilation.

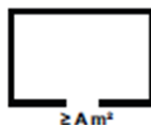

Case	Do not exceed Max Load (evenly distributed) per pan.
FS-OB35	150 lbs. (68.1 kg)
FS-OB46	100 lbs. (45.4kg)
FS-OB58	125 lbs. (56.7 kg)
FS-OB70	150 lbs. (68.1 kg)

Case	Do not exceed Max Load (evenly distributed) per shelf.
FS-OB35	50 lbs. (22.7 kg)
FS-OB46	65 lbs. (29.5 kg)
FS-OB58	80 lbs. (36.3 kg)
FS-OB70	95 lbs. (43.1 kg)

User Information- Clearances

CAUTION: Obstructing air vents will affect case performance which could potentially lead to case failure (source of critical intake/exhaust air flow to the compressor).

See page 13 for clearance requirements.

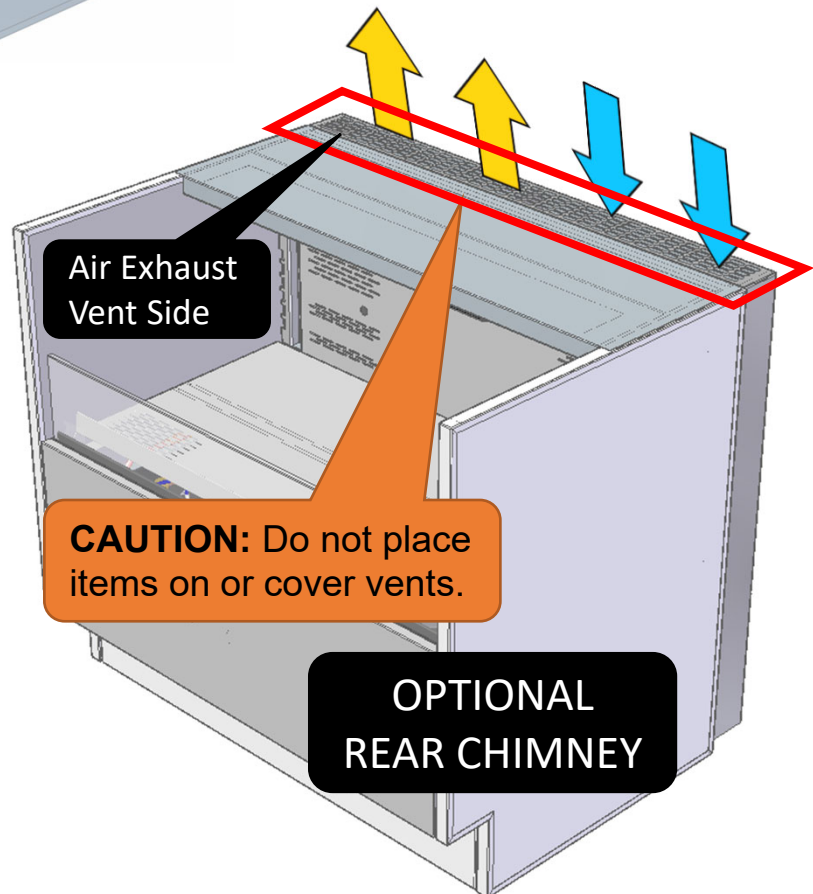
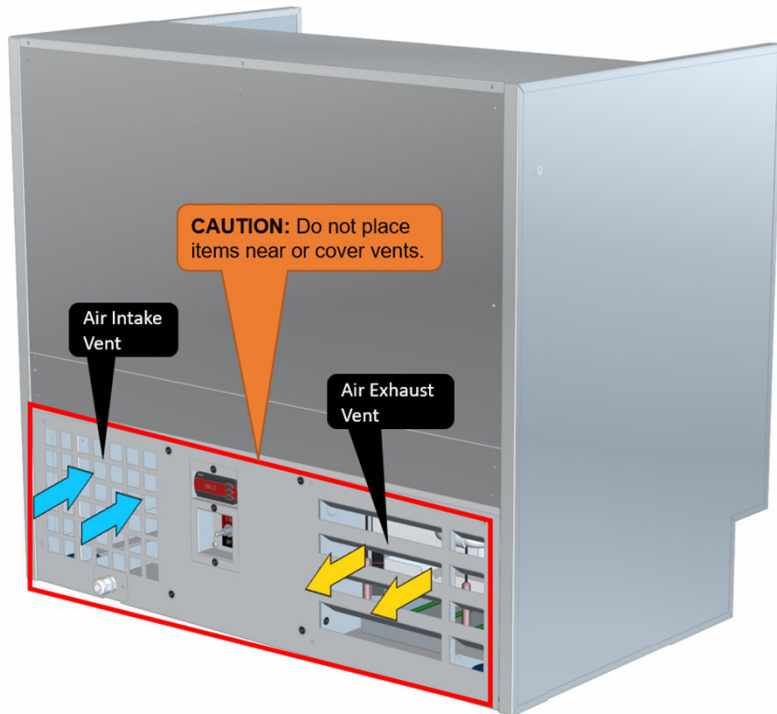

User Information- Millwork Counter Clearances

FS-OB MODEL

IMPORTANT NOTES:

- MINIMUM ALCOVE DIMENSIONS TO BE FREE OF ANY OBSTRUCTIONS.
- POWER CORD IS IN THE REAR OF CASE WITH 4" CLEARANCE.
- IF CASE CANNOT BE ROLLED BACKWARDS FOR SERVICE, FRONT AND LOWER PANELS (IF INCLUDED) MUST BE EASILY REMOVABLE.
- DO NOT BLOCK INTAKE OR DISCHARGE AIR, OBSERVE CLEARANCE SPACES.

MODEL	CASE WIDTH	CASE DEPTH (WITH CLEARANCE)	CASE HEIGHT	CUT OUT FOR MECHANDISING AREA		
				DEPTH "A"	WIDTH "B"	HEIGHT "C"
FSOB-1017-35A	36-1/4"	28-1/4"	32-1/2"	12-1/2"	34-1/2"	13"
FSOB-1017-46A	47-1/4"	28-1/4"	32-1/2"	12-1/2"	45-1/2"	13"
FSOB-1017-58A	59-1/4"	28-1/4"	32-1/2"	12-1/2"	57-1/2"	13"
FSOB-1017-70A	71-1/4"	28-1/4"	32-1/2"	12-1/2"	69-1/2"	13"

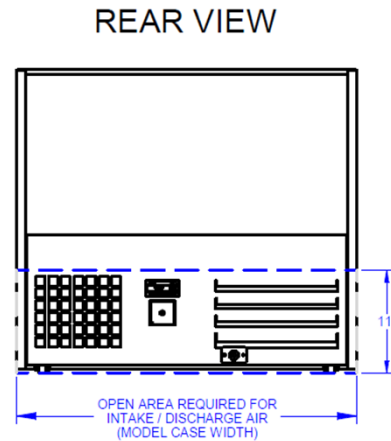
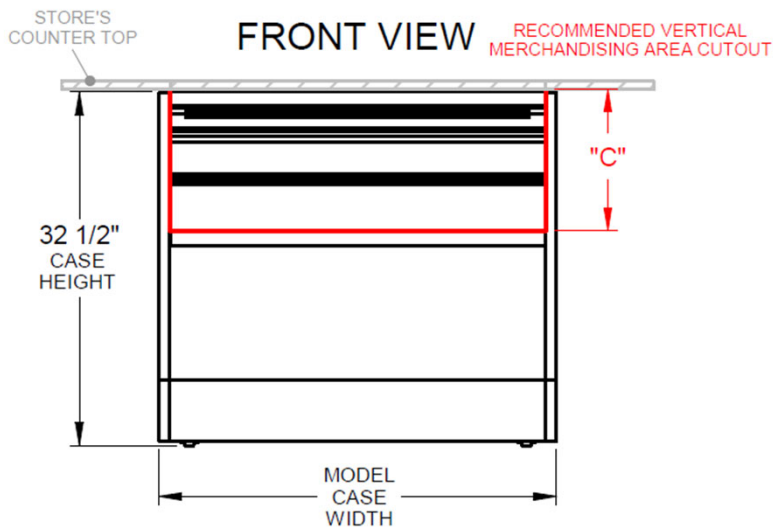
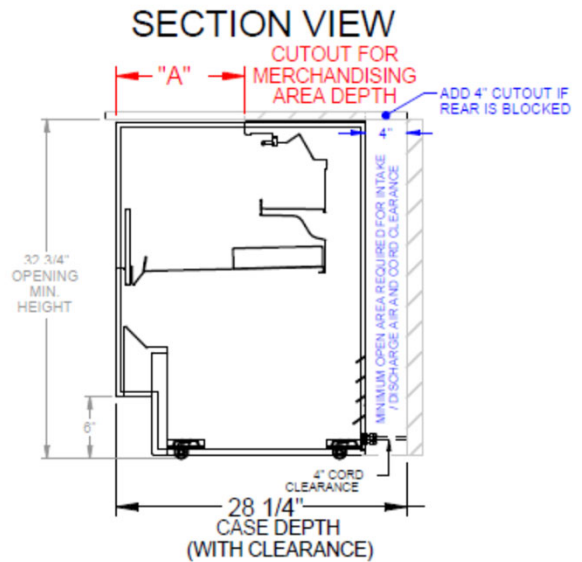
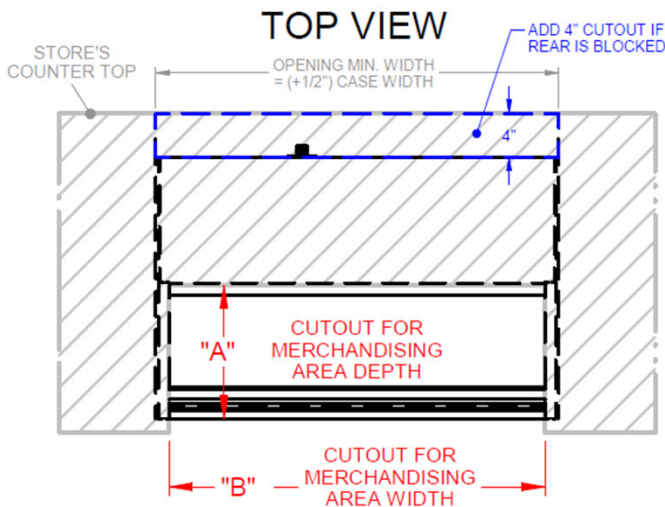

User Information

Pre-Power Checklist

- Review all safety warnings on the case and in this manual (pg. 1-4).
- Examine the entire case for any shipping damage (pg 10-11).
- The case should be level and all casters (if applicable) are in locked position (pg 12).
- Verify that the fan plenums are in place.
- Inspect all refrigeration lines for holes, dents or kinks.
- Verify that the power receptacle has matching voltage and amp ratings.
- Ensure that the case switch is in the OFF position prior to plugging the cord into the receptacle (pg 23).

Powered Up Checklist

- Verify the case temperatures and adjust the controller as needed, consult data sheet.
- Install all the exterior lower panels (pg 23).
- Allow the case to operate at least two (2) hours before placing product inside to ensure the case is at proper operating temperature.
- Load the case per loading requirements (pg 13).

User Information

Review all safety warnings on the case and in this manual (pg. 2-4) before providing any service or Maintenance

WARNINGS:

If the information in these instructions are not followed exactly, a fire or explosion may result, causing property damage or personal injury.

Installation and service must be performed by a qualified installer or service agency.

READ THE ENTIRE MANUAL BEFORE INSTALLING OR USING THIS EQUIPMENT.

The unit uses R-290 gas as the refrigerant. R-290 is flammable and heavier than air. It collects first in low areas but can be circulated by the fans. If propane gas is present or even suspected, do not allow untrained personnel to attempt to find the cause. The propane gas used in the unit has no odor. The lack of smell does not indicate a lack of escaped gas. If a leak is detected, immediately evacuate all persons from the store, and contact the local fire department to advise them that a propane leak has occurred. Do not let any persons back into the store until the qualified service technician has arrived and that technician advises that it is safe to return to the store. No open flames, cigarettes or other possible sources of ignition should be used inside or in the vicinity of the units.

FAILURE TO ABIDE BY THIS WARNING COULD RESULT IN AN EXPLOSION, INJURY AND PROPERTY DAMAGE.

IMPORTANT

Keep in store for future reference!

Maintenance

Case Cleaning

Long life and satisfactory performance of any equipment are dependent upon the care it receives. To ensure long life, proper sanitation and minimum maintenance costs, the merchandiser should be thoroughly cleaned, all debris removed, and interiors washed down weekly.

Exterior Surfaces

The exterior surfaces must be cleaned with a mild detergent without chloride and warm water to protect and maintain their attractive finish. **NEVER USE ABRASIVE CLEANSERS OR SCOURING PADS.**

Cleaning Bumpers

Clean bumpers with household spray cleaners.

Cleaning Under Merchandiser

Remove lower body panels. Use a vacuum with a long wand attachment to remove accumulated dust and debris from under the merchandiser. Use a vacuum only if it has been certified for use around flammable refrigerants.

Cleaning Stainless Steel Surfaces

Use non-abrasive cleaning materials, and always polish with the grain of the steel. Use warm water or add a mild detergent to the water and apply with a cloth. Always wipe dry after wetting.

Use non-chlorine containing cleaners such as window cleaners and mild detergents. Do not use cleaners containing salts as this may cause pitting and rusting of the stainless-steel finish. Do not use bleach.

Clean frequently to avoid build-up of hard, stubborn stains. A stainless-steel cleaning solution may be used periodically to minimize scratching and remove stains.

Rinse and wipe dry immediately after cleaning. Never use hydrochloric acid (muriatic acid) on stainless steel.

Interior Surfaces

The interior surfaces may be cleaned with most domestic detergents, ammonia-based cleaners and sanitizing solutions that do not contain chloride with no harm to the surface.

Cleaning Coils

NEVER USE SHARP OBJECTS AROUND COILS.

Use a soft brush or vacuum brush to clean debris from coils. Do not puncture Coils! Do not bend fins. Contact an authorized service technician if a coil is punctured, cracked, or otherwise damaged.

ICE in or on the coil indicates the refrigeration and defrost cycle is not operating properly. Contact an authorized Service Technician to determine the cause of icing and to make proper adjustments as necessary. To maintain product integrity, move all product to a cooler until the merchandiser has returned to normal operating temperatures.

Do Not Use:

- Abrasive cleaners and scouring pads, as these will damage the finish.
- Solvent, oil or acidic based cleaners on any interior surfaces.

Maintenance

Cleaning Condenser Coils

Coils should be cleaned at least once per month. Additional cleaning may be required depending on environment. A dirty condenser blocks normal airflow through the coils.

Airflow blockage increases energy consumption & reduces the merchandiser's ability to maintain operating temperatures.

To clean the coils, use a vacuum cleaner with a wand attachment & a soft (non-metallic) brush to remove dirt & debris. Do not bend fins. Always wear gloves & protective eye wear when cleaning near sharp coil fins & dust particles. Use a vacuum only if it has been certified for use around flammable refrigerants.

Night Curtain Tension

(In the event the spring becomes accidentally unloaded)
Remove Top Cover to access (see below).
Tension the hand spring by turning it clockwise with tool key (1) or wrench (2). Do not leave tool/wrench in spring after tensioning.
Recommended 4-8 turns.

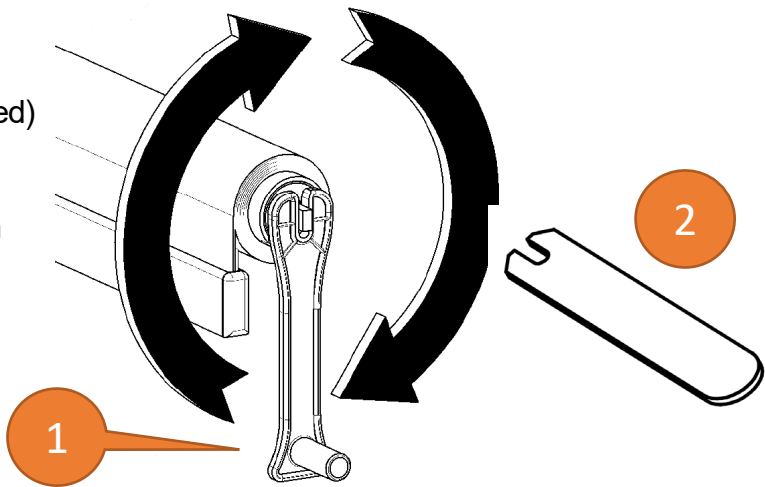

Removing Top Cover

Screwdriver / Drill bit will be required in order to remove or install Top Cover. There are two (2) screws on the front bottom edge and three (3) screws in the rear. Screw locations indicated by the red arrows in Images.

To install Panel, reverse order from above.

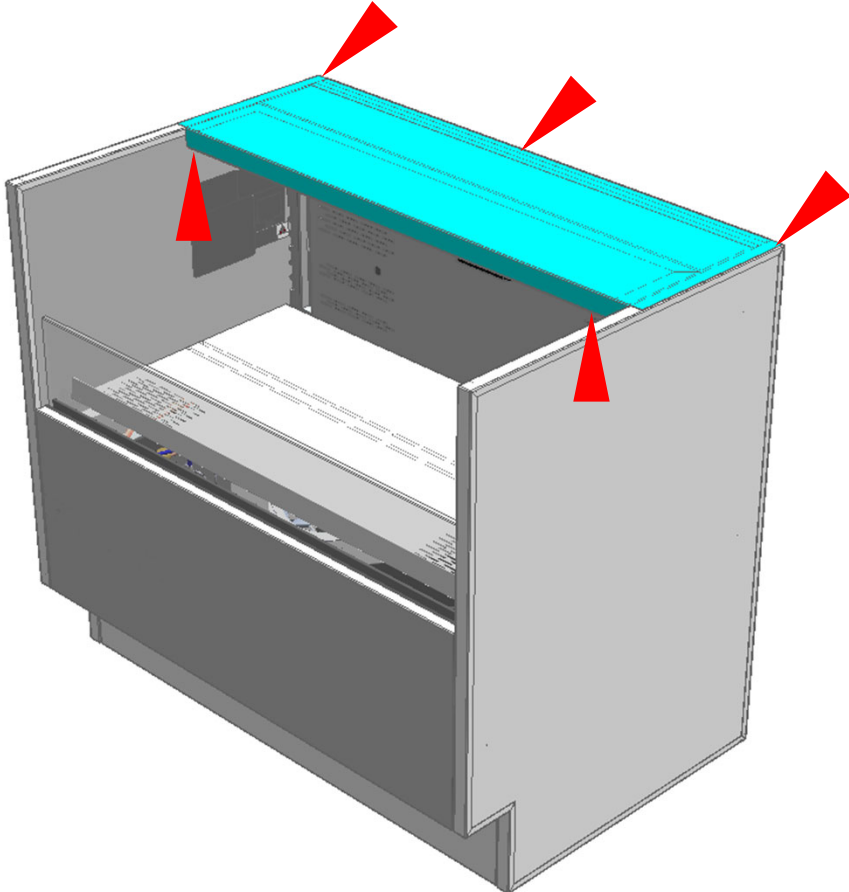

Maintenance

Condensate Evaporator Pan Maintenance

Maintenance:

Care must be taken to ensure that the condensate pans operate properly at the store. These units are designed to operate at either 75°F ambient and 55% relative humidity (RH) or 80°F ambient and 55% relative humidity (RH). If stores are operating above this condition, case performance will be severely affected. If such a condition is noted, Evaporator Pan must be checked periodically to see if excess water is being collected. If water has accumulated, water must be siphoned out of pan. Care must be taken while performing this setup. Unit power should be shut off for electrical safety. Once water has been removed and pan is dried out, unit power can be turned back on. Correct the store conditions and ensure temperature and relative humidity are within stated parameters. Call a HVAC technician if the A/C is not working properly.

See pg 24. Item 2

NSF Compliant Sealing of The Case to The Floor

When the appliance is designed to be sealed to the floor or countertop the following procedure must be followed to establish proper sanitary operation. First, ensure the floor area is clean and free from debris. Begin by positioning the appliance in its designated installation spot, ensuring sufficient clearance on the back and sides according to the specified "Clearances" for proper ventilation. Next, level the appliance from front to back and side to side, as described in "Method for Leveling." Once level, outline the base of the appliance on the floor. Then, lift and support the front of the appliance. Apply a bead of NSF-approved sealant to the floor, positioned about 1/2 inch (13 mm) inside the front part of the outline. The bead should be substantial enough to cover the entire appliance surface when lowered onto it. Afterward, raise and support the rear of the appliance and apply the sealant to the floor along the remaining three sides. Finally, carefully lower the appliance and inspect it to ensure a complete seal around the entire perimeter and clean off any extra sealant as necessary. Once the appliance is sealed in accordance with these procedures, the result is intended to prevent liquid spillage on adjacent surfaces of the floor or countertop from passing under inaccessible portions of the equipment.

Cleaning Honeycomb

Dirty honeycomb blocks normal air flow. Honeycomb should be inspected at least once per month. Clean as necessary after inspection. More frequent inspection/cleaning may be required depending on the environment.

Cleaning Process Overview:

- Remove the product and all loose debris to avoid clogging the waste outlet.
- Store product in a refrigerated area such as a cooler during the cleaning process.
- Remove only as much product as can be taken to the cooler in a timely manner.
- **First, turn off refrigeration, then disconnect electrical power to merchandiser.**
- Thoroughly clean all surfaces with soap and hot water.
 - Do not use steam or high-pressure water hoses to wash the interior.
 - These techniques will damage sealing causing leaks and poor performance.
- Avoid direct contact between fan motors and cleaning or rinse water.
- While cleaning, ensure that the condensate pans are cleared of foreign debris. These pans are designed for water only.
- Rinse with hot water, but DO NOT flood.
 - Never introduce water faster than the waste outlet can drain.
- Allow merchandiser to completely dry before resuming operation.
- After cleaning has been completed, remember to restore refrigeration and power back to merchandiser.

Electrical

Merchandiser Electrical Data

The data sheets provide merchandiser electrical data. Refer to the technical data sheets and merchandiser serial plate for electrical information.

Electrical Connections

All wiring must comply with NEC and local codes. All electrical connections including both supply circuits are to be made in the electrical J-Box.

Field Wiring

Field wiring must be sized for component amperes stamped on the serial plate (refer to page 29 for location). Actual ampere draw may be less than specified.

Identification of Wiring

Leads for all electrical circuits are identified by colored plastic bands. These bands correspond to the color code sticker (shown below) located inside the merchandiser's wireway cover.

Electrical

Where electrical components are being changed, they shall be fit for the purpose and to the correct specification. At all times, the manufacturer's maintenance and service guidelines shall be followed. If in doubt, consult the manufacturer's technical department for assistance.

⚠ WARNING

— LOCK OUT / TAG OUT —

To avoid serious injury from electrical shock, always disconnect the electrical power at the main disconnect when servicing or replacing any electrical component. This includes, but is not limited to, such items as doors, lights, fans, heaters, and thermostats.

STANDARD CASE WIRE COLOR CODE CODIGO DE COLORES DE LOS ALAMBRES PARA LAS VITRINAS ESTANDAR CODE COULER POUR FILS DE BOITIER NORMALISE		
COLOR DESCRIPTION	DESCRIPCION	DESCRIPTION
■ GROUND	TIERRA MASA	MASSE
■ ANTI-SWEAT	ANTICONDENSACION	ANTI-SUINTEMENT
■ LIGHTS	LUCES	ECLAIRAGE
■ RECEPTACLES	ENCHUFES	PRISE DE COURANT
■ T-STAT/SOLENOID 230VAC	TERMOSTATO/SOLENOIDE (230VAC)	SOUPAPE A SOLENOID (230 VAC)
■ T-STAT/SOLENOID 115VAC	TERMOSTATO/SOLENOIDE (115VAC)	SOUPAPE A SOLENOID (115 VAC)
■ T-STAT/SOLENOID 24VAC	TERMOSTATO/SOLENOIDE (24VAC)	SOUPAPE A SOLENOID (24 VAC)
■ FAN MOTORS	VENTILADORES	VENTILATEUR
BLUE CONDENSING UNIT	UNIDAD DE CONDENSACION	UNITE DE CONDENSATION

USE COPPER CONDUCTORS ONLY
UTILISEZ LES CONDUCTEURS DE CUIVRE SEULEMENT
UTILICE LOS CONDUCTORES DE COBRE SOLAMENTE

430-01-0338 R101003

Electrical

Electrical

Repair and maintenance to electrical components shall include initial safety checks and component inspection procedures. If a fault exists that could compromise safety, then no electrical supply shall be connected to the circuit until it is satisfactorily dealt with. If the fault cannot be corrected immediately but it is necessary to continue operation, an adequate temporary solution shall be used. This shall be reported to the owner of the equipment, so all parties are advised.

Initial safety checks shall include:

- a) that capacitors are discharged: this shall be done in a safe manner to avoid possibility of sparking;
- b) that no live electrical components and wiring are exposed while charging, recovering or purging the system;
- c) that there is continuity of earth bonding.

During repairs to sealed components, all electrical supplies shall be disconnected from the equipment being worked upon prior to any removal of sealed covers, etc. If it is absolutely necessary to have an electrical supply to equipment during servicing, then a permanently operating form of leak detection shall be located at the most critical point to warn of a potentially hazardous situation.

Particular attention shall be paid to the following to ensure that by working on electrical components, the casing is not altered in such a way that the level of protection is affected. This shall include damage to cables, excessive number of connections, terminals not made to original specification, damage to seals, incorrect fitting of glands, etc.

- a) Ensure that the apparatus is mounted securely.
- b) Ensure that seals or sealing materials have not degraded to the point that they no longer serve the purpose of preventing the ingress of flammable atmospheres. Replacement parts shall be in accordance with the manufacturer's specifications.

*No extension cords to be used with cabled plugs. Must be a dedicated circuit.

ALWAYS CHECK THE SERIAL PLATE FOR COMPONENT AMPERES



Check that cabling will not be subject to wear, corrosion, excessive pressure, vibration, sharp edges, or any other adverse environmental effects. The check shall also take into account the effects of aging or continual vibration from sources such as compressors or fans.

Do not apply any permanent inductive or capacitance loads to the circuit without ensuring that this will not exceed the permissible voltage and current permitted for the equipment in use.

Intrinsically safe components are the only types that can be worked on while live in the presence of a flammable atmosphere. The test apparatus shall be at the correct rating.

Replace components only with parts specified by the manufacturer. Other parts can result in the ignition of refrigerant in the atmosphere from a leak.

Power Cord Plug Types

	FS-OB-35 FS-OB-46 FS-OB-58	FS-OB-70
Standard	 <p style="text-align: center;">5-15P</p>	 <p style="text-align: center;">L5-20P</p>
Optional	 <p style="text-align: center;">L5-15P</p>	

Electrical Component Locations

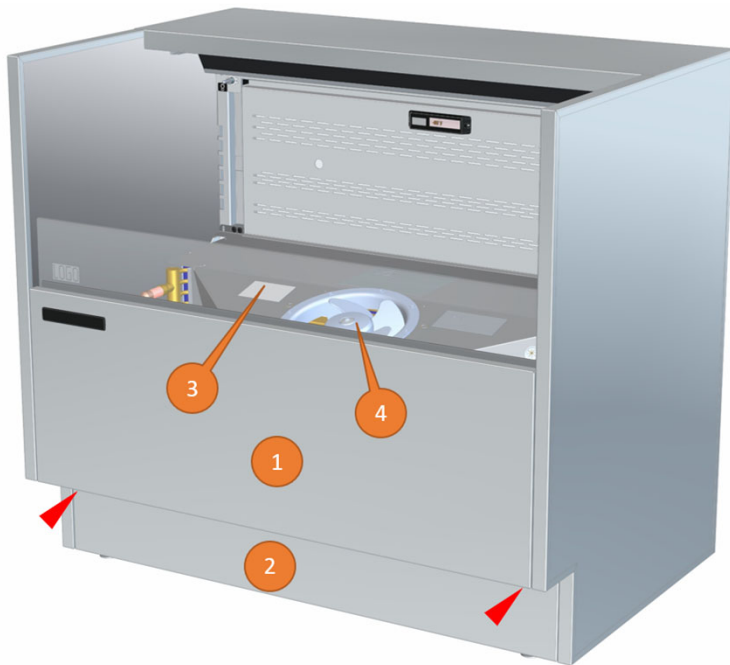

Removing Panels

The front upper panel can be removed by lifting up and out (no tools required).

Screwdriver/Drill bit will be required in order to remove or install front lower panel & rear lower panel. Two (2) screws are used for the front lower panel. There are eight (8) screws on the rear lower panel. Screw locations indicated by the red arrows in images.

To install Panel, reverse order from above.

1. Front Upper Panel
2. Front Lower Panel
3. Evaporator Fan Harness Disconnect
4. Evaporator Fan Motor
5. Rear Lower Panel
6. Cord Tie-in
7. Controller & Display
8. Main Power Switch

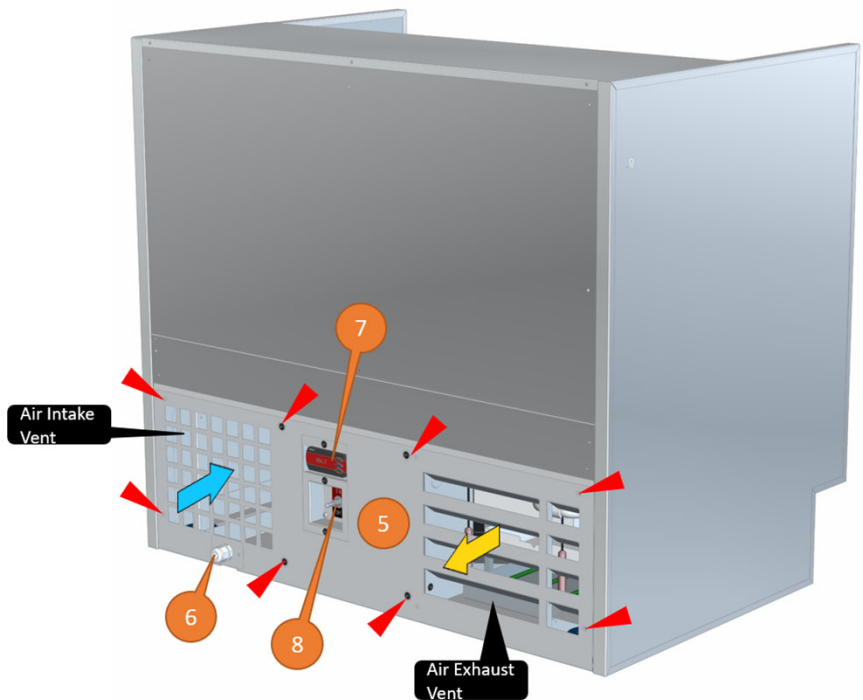

WARNING

Component parts are specifically chosen for propane exposure and therefore non-incendive and non-sparkling. Component parts shall be replaced with identical components and servicing shall be done by factory authorized service personnel only, so as to minimize the risk of possible ignition due to incorrect parts or improper service.

Self-Contained Component Locations

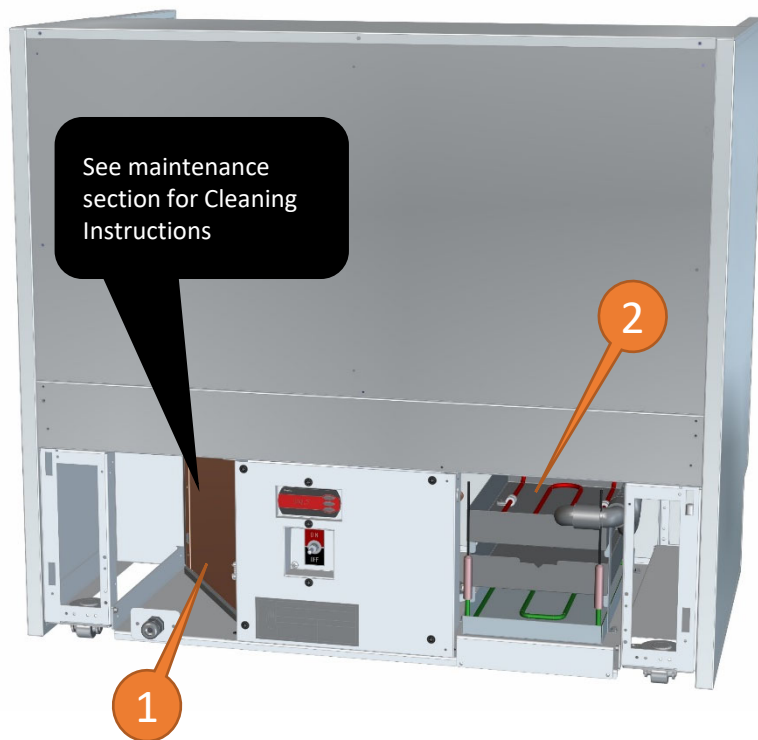

1. Compressor Unit
2. Evaporator Pan Assy

	FS-OB-1017-35A		FS-OB-1017-46A		FS-OB-1017-58A		FS-OB-1017-70A	
Part	Part #	Qty	Part #	Qty	Part #	Qty	Part #	Qty
Night Curtain	3207670	1	3208904	1	3209051	1	3207594	1
Glass - Front Sill 5"	3207665	1	3198089	1	3209033	1	3207585	1
Glass - Front Sill 10"	3220846	1	3220848	1	3220849	1	3220845	1
Fan Motor - Evaporator	3172574	1	3172573	2	3174935	2	3172573	2
Evaporator Coil	0534326	1	0534327	1	0534327	1	0534326	2
Fan Harness for Evaporator Motor	0376609	1	0376609	1	0443521A	1	0376609	2
Caster	3052217	4	3052217	4	3052217	6	3052217	6
Canopy LED 18 IN 3500K	3181555	2	N/A	-	N/A	-	N/A	-
Canopy LED 24 IN 3500K	N/A	-	3181556	2	3181556	1	N/A	-
Canopy LED 36 IN 3500K	N/A	-	N/A	-	3181557	1	3181557	2
Light Switch - On / Off	3074549	1	3074549	1	3074549	1	3074549	1
Compressor Unit	3209457	1	3209459	1	3209459	1	3209460	1
Controller - Program AK-CC210	3216304	1	3216303	1	3216302	1	3216301	1
Power Cord - 5-15P (Non-locking)	0521094	1	0521094	1	0521094	1	NA	-
Power Cord - L5-15P (Locking)	3196219	1	3196219	1	3196219	1	NA	-
Power Cord - L5-20P (Locking)	NA	-	NA	-	NA	-	3101126	1
LED Driver	3117868	1	3117868	1	3117868	1	3117868	1
Switch - On / Off	3038707	1	3038707	1	3038707	1	3038707	1
Fuse - 15 amp	125-01-8604	1	125-01-8604	1	125-01-8604	1	125-01-8604	1
Relay	3227985	1	3227985	1	3227985	1	3227985	1
Heater - Evap. Pan	3128441	1	3128441	1	3128441	1	3128441	1
Valve - TX	3191807	1	3191808	1	3191808	1	3191807	2
AKS11 Sensor	1H90012500	1	1H90012500	1	1H90012500	1	1H90012500	1

Controller Information

Scan the QR code below using your cell phone for controller operating manual. See next few pages for controller setpoints and parameters. Case is shipped with Type 1 Deli setpoints.



The image shows the cover of a user guide for the Danfoss AK-CC 210 controller. The cover is red with white text. At the top right, it says "ENGINEERING TOMORROW" and the Danfoss logo. Below that, it says "User Guide". The main title is "Controller for temperature control AK-CC 210". At the bottom, it says "ADAP-KOOL® Refrigeration control systems".



The image shows the Danfoss AK-CC 210 controller, a black rectangular device with a red LED display showing "888". It has a green terminal block on the top and a "SET" button on the front. The Danfoss logo is visible on the front panel.



A QR code is located in the bottom left corner of the page, intended for scanning to access the user manual.

-  Open Camera
-  iPhone User
Hold the camera up to the QR code
-  Android User
Open QR Code Reader app if necessary.
Hold the camera up to the QR code
-  Tap the notification to be taken to the destination of the QR code

Controller Information

PRGM-FS-OB35 DF210 R290		Type 1			
Parameter	Code	Unit	Default	Actual	
Temperature (set point)		°F	2	30	
Differential	r01	°F	2	6	
Max. limitation of setpoint setting	r02	°F	50	38	
Min. limitation of setpoint setting	r03	°F	-50	20	
Delay for temperature alarm after defrost	A12	Min	90	30	
High alarm limit	A13	°F	8	41	
Low alarm limit	A14	°F	-30	15	
Defrost stop temperature	d02	°F	6	48	
Interval between defrost starts	d03	hr	8	4	
Max. defrost duration	d04	Min	45	25	
Defrost Sensor (0=time, 1=S5. 2=S4)	d10	num	0	2	

PRGM-FS-OB46 DF210 R290		Type 1			
Parameter	Code	Unit	Default	Actual	
Temperature (set point)		°F	2	21	
Differential	r01	°F	2	6	
Max. limitation of setpoint setting	r02	°F	50	38	
Min. limitation of setpoint setting	r03	°F	-50	20	
Delay for temperature alarm after defrost	A12	Min	90	30	
High alarm limit	A13	°F	8	41	
Low alarm limit	A14	°F	-30	15	
Defrost stop temperature	d02	°F	6	48	
Interval between defrost starts	d03	hr	8	4	
Max. defrost duration	d04	Min	45	25	
Defrost Sensor (0=time, 1=S5. 2=S4)	d10	num	0	2	

Controller Information

PRGM-FS-OB58 DF210 R290		Type 1		
Parameter	Code	Unit	Default	Actual
Temperature (set point)		°F	2	25
Differential	r01	°F	2	6
Max. limitation of setpoint setting	r02	°F	50	38
Min. limitation of setpoint setting	r03	°F	-50	20
Delay for temperature alarm after defrost	A12	Min	90	30
High alarm limit	A13	°F	8	41
Low alarm limit	A14	°F	-30	15
Defrost stop temperature	d02	°F	6	48
Interval between defrost starts	d03	hr	8	4
Max. defrost duration	d04	Min	45	25
Defrost Sensor (0=time, 1=S5. 2=S4)	d10	num	0	2

PRGM-FS-OB70 DF210 R290		Type 1		
Parameter	Code	Unit	Default	Actual
Temperature (set point)		°F	2	29
Differential	r01	°F	2	6
Max. limitation of setpoint setting	r02	°F	50	38
Min. limitation of setpoint setting	r03	°F	-50	20
Delay for temperature alarm after defrost	A12	Min	90	30
High alarm limit	A13	°F	8	41
Low alarm limit	A14	°F	-30	15
Defrost stop temperature	d02	°F	6	48
Interval between defrost starts	d03	hr	8	4
Max. defrost duration	d04	Min	45	35
Defrost Sensor (0=time, 1=S5. 2=S4)	d10	num	0	2

Leak Detection

Under no circumstances shall potential sources of ignition be used in the searching for or detection of refrigerant leaks. A halide torch (or any other detector using a naked flame) shall not be used.

The following leak detection methods are deemed acceptable for all refrigerant systems.

Electronic leak detectors may be used to detect refrigerant leaks but, in the case of FLAMMABLE REFRIGERANTS, the sensitivity might not be adequate, or might need recalibration. (Detection equipment shall be calibrated in a refrigerant-free area.) Ensure that the detector is not a potential source of ignition and is suitable for the refrigerant used. Leak detection equipment shall be set at a percentage of the LFL of the refrigerant and shall be calibrated to the refrigerant employed, and the appropriate percentage of gas (25 % maximum) is confirmed.

NOTE The use of silicon sealant can inhibit the effectiveness of some types of leak detection equipment. Intrinsically safe components do not have to be isolated prior to working on them.

Leak detection fluids are also suitable for use with most refrigerants but the use of detergents containing chlorine shall be avoided as the chlorine can react with the refrigerant and corrode the copper pipe-work.

NOTE Examples of leak detection fluids are

- bubble method,
- fluorescent method agents.

If a leak is suspected, all naked flames shall be removed/extinguished.

If a leakage of refrigerant is found which requires brazing, all of the refrigerant shall be recovered from the system, or isolated (by means of shut off valves) in a part of the system remote from the leak.

Don't unplug any device if a leak is detected or suspected.

Refrigeration

Refrigerant

The correct type of refrigerant will be stamped on each merchandiser's serial plate. See the following image for serial plate location.

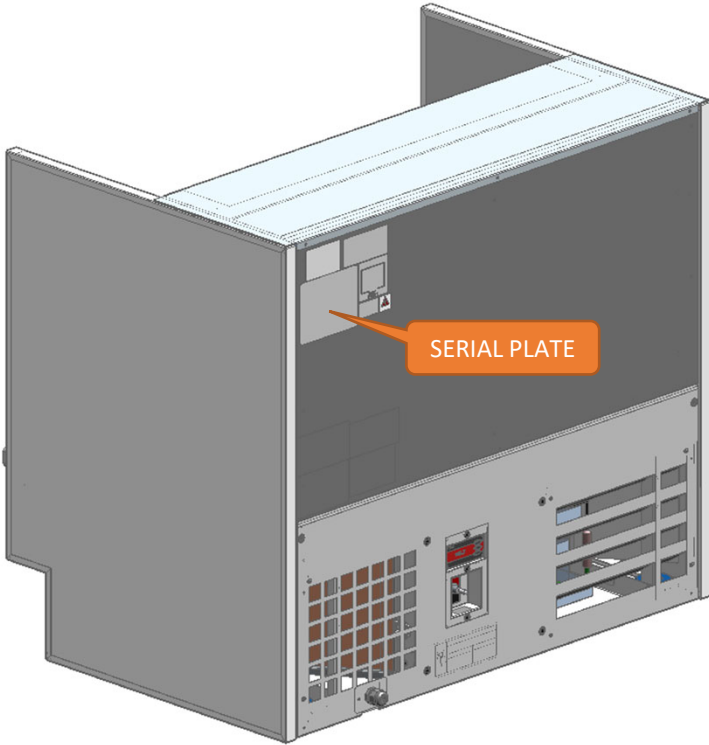

**ATTENTION
INSTALLER**

It is the contractor's responsibility to install case(s) according to local construction and health codes.

Case	R-290 Refrigerant Charge
FS-OB-1017-35A	110 grams (.24 Lbs.)
FS-OB-1017-46A	120 grams (.27 Lbs.)
FS-OB-1017-58A	130 grams (.29 Lbs.)
FS-OB-1017-70A	150 grams (.33 Lbs.)

⚠ CAUTION

Refrigeration lines are under pressure. Refrigerant must be recovered before attempting to make any connections.

⚠ WARNING

— LOCK OUT / TAG OUT —

To avoid serious injury from electrical shock, always disconnect the electrical power at the main disconnect when servicing or replacing any electrical component. This includes, but is not limited to, such items as doors, lights, fans, heaters, and thermostats.



Refrigeration

Before Beginning Any Service or Repair:

Use a hand-held propane leak detector (“sniffer”) to ensure no propane is present in the immediate area, the inside of the display case and the inside of the refrigeration system. R-290 (Propane) is an odorless refrigerant. Keep the area clear of all customers and non-essential or unauthorized personnel.

Verify that all repair parts are identical models to the ones they are replacing. Do not substitute parts such as motors, switches, relays, heaters, compressors, power supplies or solenoids.

Failure to do so can result in serious injury and property damage. Parts used on cases using flammable refrigerant must meet specific UL certification for non-incendive or non-sparking components.

Use only Hussmann approved parts approved through the Hussmann Performance Parts Website. <https://parts.hussmann.com/>

Brazing must not begin until all propane has been cleared from the immediate area — the inside of the displays case and the inside of the refrigeration system.

<p>If a leak is detected, follow store safety procedures. It is the store’s responsibility to have a written safety procedure in place. The safety procedure must comply with all applicable codes such as local fire department’s codes.</p> <p>At minimum, the following actions are required:</p> <ul style="list-style-type: none"> • Immediately evacuate all persons from the store, and contact the local fire department to advise them that a propane leak has occurred. • Call Hussmann and/or a qualified service agent and inform them that a propane sensor has detected the presence of propane. • Do not let any persons back into the store until the qualified service technician has arrived and that technician advises that it is safe to return to the store. 	<ul style="list-style-type: none"> • The propane gas used in the unit has no odor. The lack of smell does not indicate a lack of escaped gas. • A hand-held propane leak detector (“sniffer”) should be used before any repair and/ or maintenance is attempted. All repair parts must be identical models to the ones they are replacing. • No open flames, cigarettes or other possible sources of ignition should be used inside the building where the units are located until the qualified service technician and/or local fire department determines that all propane has been cleared from the area and from the refrigeration systems.
---	--

Refrigeration

Refrigerant Removal and Evacuation

When breaking into the refrigerant circuit to make repairs – or for any other purpose – conventional procedures shall be used. However, for flammable refrigerants it is important that best practice be followed, since flammability is a consideration. The following procedure shall be adhered to:

- a) safely remove refrigerant following local and national regulations;
- b) purge the circuit with inert gas;
- c) evacuate;
- d) purge with inert gas;
- e) open the circuit by cutting or brazing.

The refrigerant charge shall be recovered into the correct recovery cylinders if venting is not allowed by local and national codes. For appliances containing flammable refrigerants, the system shall be purged with oxygen-free nitrogen to render the appliance safe for flammable refrigerants. This process might need to be repeated several times. Compressed air or oxygen shall not be used for purging refrigerant systems.

For appliances containing flammable refrigerants, refrigerants purging shall be achieved by breaking the vacuum in the system with oxygen-free nitrogen and continuing to fill until the working pressure is achieved, then venting to atmosphere, and finally pulling down to a vacuum. This process shall be repeated until no refrigerant is within the system. When the final oxygen-free nitrogen charge is used, the system shall be vented down to atmospheric pressure to enable work to take place.

Ensure that the outlet for the vacuum pump is not close to any potential ignition sources and that ventilation is available.

System Charging

In addition to conventional charging procedures, the following requirements shall be followed.

- a) Ensure that contamination of different refrigerants does not occur when using charging equipment. Hoses or lines shall be as short as possible to minimize the amount of refrigerant contained in them.
- b) Cylinders shall be kept in an appropriate position according to the instructions.
- c) Ensure that the REFRIGERATING SYSTEM is earthed prior to charging the system with refrigerant.
- d) Label the system when charging is complete (if not already).
- e) Extreme care shall be taken not to overfill the REFRIGERATING SYSTEM.

Prior to recharging the system, it shall be pressure-tested with the appropriate purging gas. The system shall be leak-tested on completion of charging but prior to commissioning. A follow up leak test shall be carried out prior to leaving the site.

A calibrated scale with +/-2 gram accuracy must be used to charge the system. The charge amount is shown on the serial plate. Only R-290 (Propane) grade refrigerant can be used. Standard propane does not meet the purity/moisture content of R-290 (Propane), and therefore cannot be used to charge cases.

Charge value should be as shown on page 29. When connecting hoses between the refrigeration system, manifold gauges, and refrigerant cylinder, ensure that the connections are secure and there are no potential sources of ignition nearby. Ensure that contamination of different refrigerants does not occur when using charging equipment.

Refrigeration

Refrigerant Recovery

When removing refrigerant from a system, either for servicing or decommissioning, it is recommended good practice that all refrigerants are removed safely.

When transferring refrigerant into cylinders, ensure that only appropriate refrigerant recovery cylinders are employed. Ensure that the correct number of cylinders for holding the total system charge is available. All cylinders to be used are designated for the recovered refrigerant and labelled for that refrigerant (i.e., special cylinders for the recovery of refrigerant). Cylinders shall be complete with pressure-relief valve and associated shut-off valves in good working order. Empty recovery cylinders are evacuated and, if possible, cooled before recovery occurs.

The recovery equipment shall be in good working order with a set of instructions concerning the equipment that is at hand and shall be suitable for the recovery of all appropriate refrigerants including, when applicable, FLAMMABLE REFRIGERANTS. In addition, a set of calibrated weighing scales shall be available and in good working order. Hoses shall be complete with leak-free disconnect couplings and in good condition. Before using the recovery machine, check that it is in satisfactory working order, has been properly maintained and that any associated electrical components are sealed to prevent ignition in the event of a refrigerant release. Consult manufacturer if in doubt.

The recovered refrigerant shall be returned to the refrigerant supplier in the correct recovery cylinder, and the relevant waste transfer note arranged. Do not mix refrigerants in recovery units and especially not in cylinders.

If compressors or compressor oils are to be removed, ensure that they have been evacuated to an acceptable level to make certain that FLAMMABLE REFRIGERANT does not remain within the lubricant. The evacuation process shall be carried out prior to returning the compressor to the suppliers. Only electric heating to the compressor body shall be employed to accelerate this process. When oil is drained from a system, it shall be carried out safely.

1. Tap system with line tap valves, attaching gauges to the high and low sides of the system.



**refrigeration
line tapping
valve**

2. Connect hose to an evacuated recovery tank. Open refrigeration gauges and recovery tank.

3. With the suction valve in vacuum, the refrigerant will be recovered into the recovery tank.

4. Once recovered, close the tank valve and remove the gauge from the tank and connect nitrogen tank to the system to purge it with nitrogen.

5. Pull vacuum to a minimum of 200 microns or lower.



Refrigeration

Decommissioning

Before carrying out this procedure, it is essential that the technician is completely familiar with the equipment and all its detail. It is recommended good practice that all refrigerants are recovered safely. Prior to the task being carried out, an oil and refrigerant sample shall be taken in case analysis is required prior to re-use of recovered refrigerant. It is essential that electrical power is available before the task is commenced.

- a) Become familiar with the equipment and its operation.
- b) Isolate the system electrically.
- c) Before attempting the procedure, ensure that:
 - i) mechanical handling equipment is available, if required, for handling refrigerant cylinders;
 - ii) all personal protective equipment is available and being used correctly;
 - iii) the recovery process is supervised at all times by a competent person;
 - iv) recovery equipment and cylinders conform to the appropriate standards.
- d) Pump down refrigerant system, if possible.
- e) If a vacuum is not possible, make a manifold so that refrigerant can be removed from various parts of the system.
- f) Make sure that cylinder is situated on the scale before recovery takes place.
- g) Start the recovery machine and operate in accordance with instructions.
- h) Do not overfill cylinders (no more than 80% volume liquid charge).
- i) Do not exceed the maximum working pressure of the cylinder, even temporarily.
- j) When the cylinders have been filled correctly and the process completed, make sure that the cylinders and the equipment are removed from site promptly and all isolation valves on the equipment are closed off.
- k) Recovered refrigerant shall not be charged into another REFRIGERATING SYSTEM unless it has been cleaned and checked.

Equipment shall be labelled stating that it has been de-commissioned and emptied of refrigerant. The label shall be dated and signed. For appliances containing FLAMMABLE REFRIGERANTS, ensure that there are labels on the equipment stating the equipment contains FLAMMABLE REFRIGERANT.

Water Outlet And Water Seal

The condensate water outlet is located in the center of the merchandiser. The outlet has a factory installed, external water seal.

For self contained models, this water seal drains into the condensate evaporator pan located beneath the merchandiser. Ensure the drain hose is properly trapped, and the drain area is not clogged

NOTE: All lower base panels must be in place when the refrigerator is operating. If not, air-flow from the condenser will be directed over the evaporator pan and defrost water in the pan may overflow.



Troubleshooting

Problem	Possible Cause	Possible Solution
Case temperature is too warm.	Ambient conditions may be affecting the case operation.	Check case position in store. Is the case located near an open door, window, electric fan or air conditioning vent that may cause air currents? Case must be located minimum 15 Ft away from doors or windows. Cases are designed to operate at 55% Relative humidity and a temperature of 75-80°F.
	Discharge air temp is out of spec.	Check evaporator fan operation. Check electrical connections and input voltage.
		Fans are installed backwards. Check airflow direction.
		Fan blades are installed incorrectly. Make sure fan blades have correct pitch and are per specification.
		Check to see that fan plenum is installed correctly. It should not have any gaps.
	Case is in defrost.	Check defrost settings. See Technical Specifications section.
	Product is outside of the load limit area, blocking airflow.	Redistribute product so it does not exceed load limit. There is a sticker on the inside of the case indicating what the maximum load line is. See page 13 for details.
Coil is freezing over.	Return air is blocked, make sure debris is not blocking the intake section.	
	Coil close-offs are not installed. Inspect coil to make sure these parts are on the case.	
Condensing coil or evaporator coil is clogged or dirty.	Clean coil.	
Case temperature is too cold.	The t-stat temp is set too low.	Check settings. See Technical Specifications section.
	Ambient conditions may be affecting the case operation.	Check case position in store. Is the case located near an open door, window, electric fan or air conditioning vent that may cause air currents? Case must be located minimum 15 Ft away from doors or windows. Cases are designed to operate at 55% Relative humidity and a temperature of 75-80°F.
Condensation on plex / glass.	Ambient conditions may be affecting the case operation.	Check case position in store. Is the case located near an open door, window, electric fan or air conditioning vent that may cause air currents? Case must be located minimum 15 Ft away from doors or windows. Cases are designed to operate at 55% Relative humidity and a temperature of 75-80°F.

Troubleshooting Cont'd

Problem	Possible Cause	Possible Solution
Water has pooled under case.	Case drain is clogged.	Clear drain.
	PVC drains under case may have a leak.	Repair as needed.
	Case tub has unsealed opening.	Seal as needed.
	If the case is in a line-up, case to case joint is missing or unsealed.	Install case to case joint and seal as needed.
	Evaporator pan is overflowing (if applicable).	Check electrical connection to evaporator pan. Check float assembly, it should move freely up and down the support stem. Clear any debris.
Case is not draining properly.	Case is not level.	Level the case.
	Drain screen is plugged.	Clean drain screen and remove any debris.
	Drain or P-trap is clogged.	Clear any debris.
Frost or ice on evaporator coil.	Evaporator fans are not functioning.	Check electrical connections.
	Defrost clock is not functioning.	Case should be serviced by a qualified service technician.
	Coil is freezing over.	Return air is blocked, make sure debris is not blocking the intake section.
Coil close-offs are not installed. Inspect coil to make sure these parts are on the case.		

Service

Evaporator Fan Replacement.

Disconnect electrical power before starting motor replacement. Lift and remove deck pans (1) to access fan plenum (3). The fan plenum may be removed from the case for easier access if needed. Remove screws (4) from the top of the fan motor assy. Disconnect motor connection and remove fan motor assy.

See Image Below.

To install, reverse order from above.

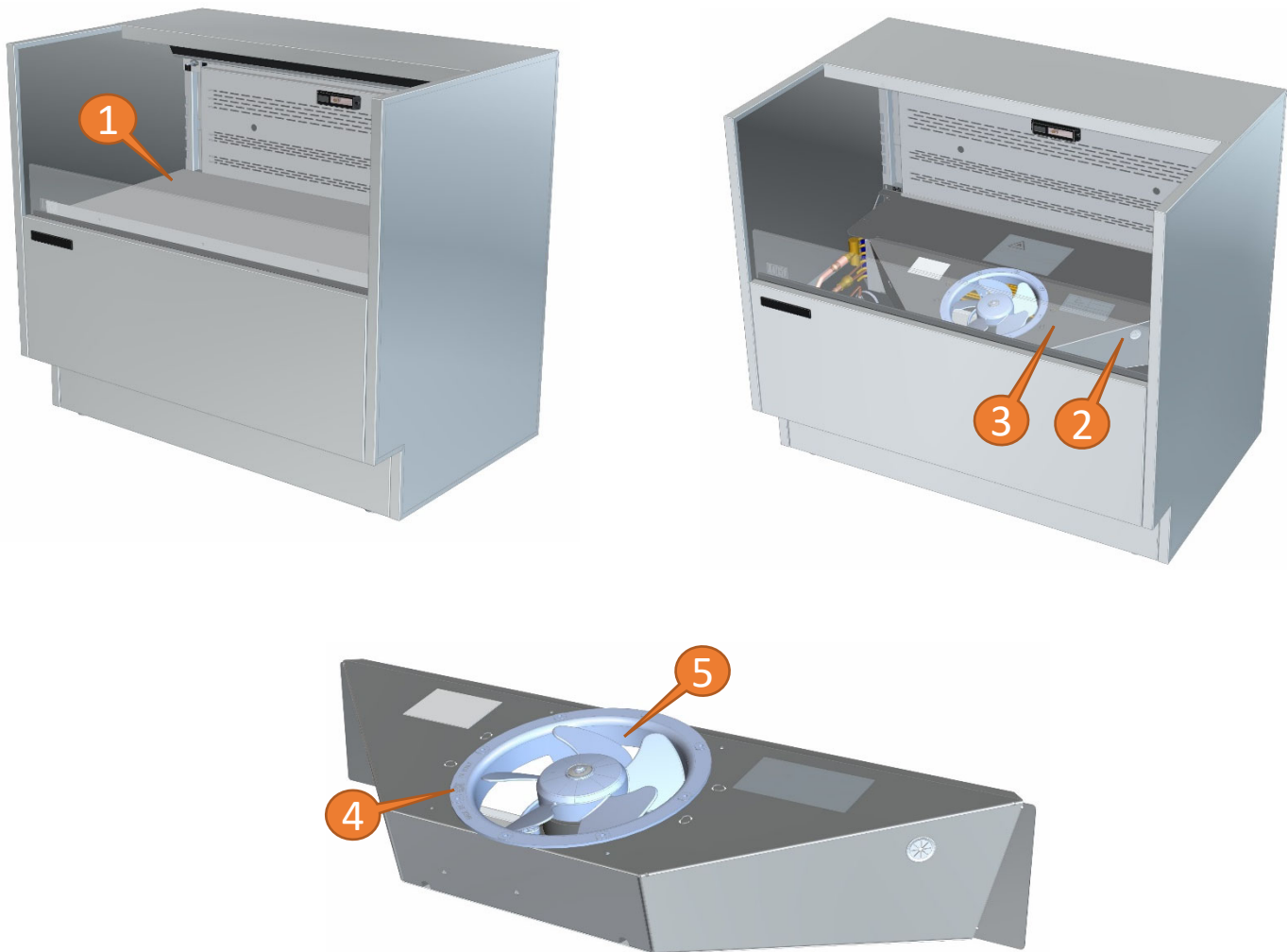

1. Deck Pan
2. Fan Harness
3. Fan Plenum
4. Screw
5. Fan Motor

Service cont'd

LED Driver Replacement

Disconnect electrical power before starting LED Driver replacement. Remove Lower Rear Panel to access Junction Box. Junction Box cover needs to be removed to access the LED driver, remove screws (red arrows indicate locations). Disconnect LED Driver wires from connector/blocks/harnesses (noting existing locations). Refer to wiring diagram for reference. Wiring diagram can be found at www.Husmann.com. Search for "FS-OB" and scroll to "Datasheet" link. Remove screws holding LED Driver (red arrows indicate locations) and replace. Reverse order to connect LED Driver and install all covers.

See Image Below.

See page 23 for panel removal

- 6. Junction Box / Field Tie-in
- 7. LED Driver

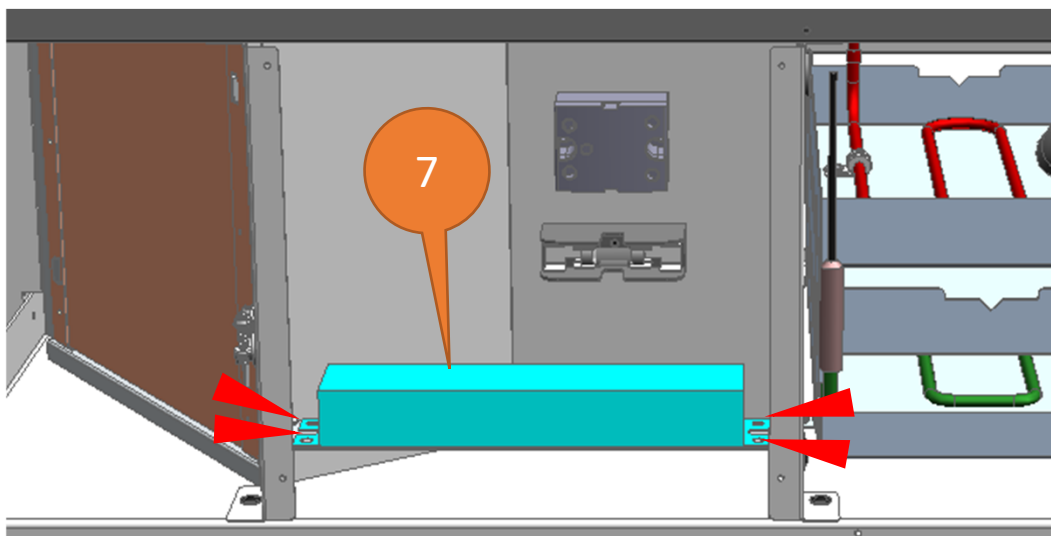
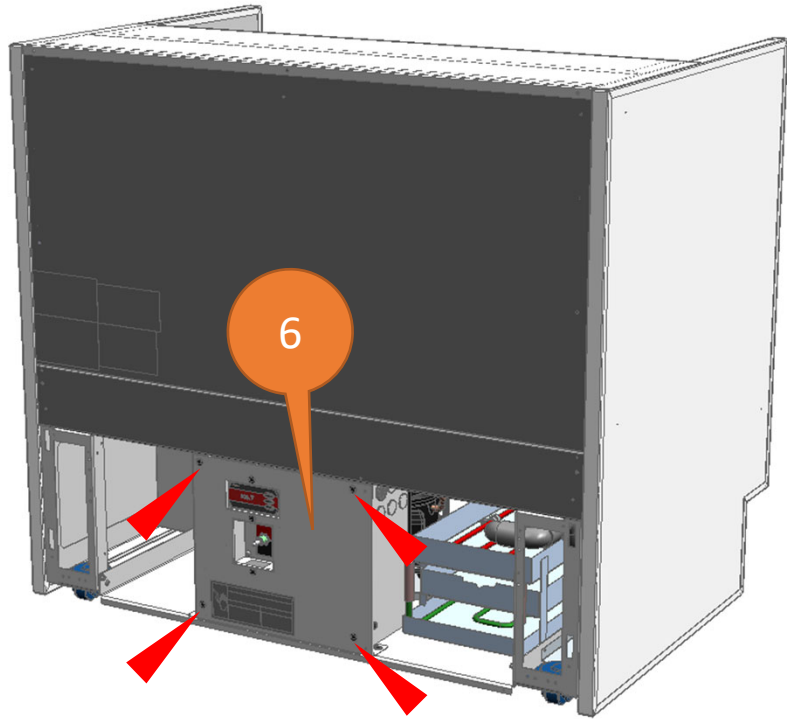

Service cont'd

Every working procedure that affects safety means shall only be carried out by competent persons.

Prior to beginning work on systems containing flammable refrigerants, safety checks are necessary to ensure that the risk of ignition is minimized.

The following checks shall be applied to installations using flammable refrigerants:

- a) The actual refrigerant charge is in accordance with the room size within which the refrigerant containing parts are installed.
- b) The ventilation machinery and outlets are operating adequately and are not obstructed.
- c) If an indirect refrigerating circuit is being used, the secondary circuit shall be checked for the presence of refrigerant.
- d) Marking to the equipment continues to be visible and legible. Markings and signs that are illegible shall be corrected.
- e) Refrigerating pipe or components are installed in a position where they are unlikely to be exposed to any substance which may corrode refrigerant containing components, unless the components are constructed of material which are inherently resistant to being corroded or are suitably protected against being so corroded.

Work shall be undertaken under a controlled procedure so as to minimize the risk of a flammable gas or vapour being present while the work is being performed.

All maintenance staff and others working in the local area shall be instructed on the nature of work being carried out. Work in confined spaces shall be avoided.

The area shall be checked with an appropriate refrigerant detector prior to and during work, to ensure the technician is aware of potentially toxic or flammable atmospheres. Ensure that the leak detection equipment being used is suitable for use with all applicable refrigerants, i.e., nonsparking, adequately sealed, or intrinsically safe.

If any hot work is to be conducted on the refrigerating equipment or any associated parts, appropriate fire extinguishing equipment shall be available on hand. A dry chemical or CO₂ fire extinguisher should be adjacent to the charging area.

No person carrying out work in relation to a REFRIGERATING SYSTEM which involves exposing any pipe work shall use any sources of ignition in such a manner that it may lead to the risk of fire or explosion. All possible ignition sources, including cigarette smoking, should be kept sufficiently far away from the site of installation, repairing, removing and disposal, during which refrigerant can possibly be released to the surrounding space. Prior to work taking place, the area around the equipment shall be surveyed to make sure that there are no flammable hazards or ignition risks. "No Smoking" signs shall be displayed.

Ensure that the area is in the open or that it is adequately ventilated before breaking into the system or conducting any hot work. A degree of ventilation shall continue during the period that the work is carried out. The ventilation should safely disperse any released refrigerant and preferably expel it externally into the atmosphere.

WARNING

— LOCK OUT / TAG OUT —

To avoid serious injury from electrical shock, always disconnect the electrical power at the main disconnect when servicing or replacing any electrical component. This includes, but is not limited to, such items as doors, lights, fans, heaters, and thermostats.



HUSSMANN[®]

**To obtain warranty information
or other support, contact your
Hussmann representative.
Please include the model and
serial number of the product.**

**Hussmann Warranty / Technical Assistance
(800) 592-2060**

Hussmann Corporation, Corporate Headquarters: Bridgeton, Missouri 63044 2014